

# **Operating manual**

**Tumble dryers**

**T4250, T4350**

**Type N2...**

**Selecta Control**

*Thinking of you*

 **Electrolux**



# Contents

---

## Contents

Additional safety instructions and warnings.....	4
Safety precautions .....	5
Instructions for use.....	7
Glossary .....	7
Diagram of tumble dryer.....	8
Instruction signs/operating panels .....	9
Operating panel – buttons and symbols .....	11
Programmes – AHL.....	12
Tumble dryer with manual operation – AHL.....	13
Programmes – OPL .....	14
Tumble dryer with manual operation – OPL .....	15
Programmes – Coin-operated laundries .....	16
Tumble dryer with payment.....	17
Error codes.....	19
Maintenance.....	23

The manufacturer reserves the right to make changes to design and component specifications.

### Additional safety instructions and warnings

#### Using the dryer

- **Do not** operate this appliance before reading the instruction booklet.
- **Do not** put articles containing foam rubber, plastic or similarly textured rubberlike materials in the dryer.
- **Do not** dry mopheads or articles exposed to gasoline, kerosene, paint wax, grease, combustible detergent or all purpose cleaners.
- **Do not** use heat for drying foam rubber items or similarly textured rubberlike materials.
- **Do not** put articles soiled with flammable liquids, vegetable- or cooking oils in dryer.
- **Do not** load materials containing flammable solvents into this appliance
- **Do not** reach into dryer until all moving parts have stopped.
- **Do not** let children play in or near dryer.
- **Do not** operate with panels, covers or guards removed from this appliance.
- Remove articles being dried immediately after tumbler stops.
- Lint screen must be cleaned in accordance with the manufacturer's recommended frequency guidelines.
- Avoid overdrying items such as silk and wool, as shrinkage or fabric damage may result.

#### The area surrounding the dryer

- **Do not** store or use flammable liquids near the dryer.
- **Do not** store chemicals, or spray aerosols near this appliance.
- **Do not** store or use aerosols or cleaning solvents in the vicinity of the dryer. Some chemicals used in laundries contain Chlorine (some dry-cleaning fluids, aerosols and bleach) When exposed to a flame, these chemicals may produce toxic fumes that are harmful to humans and highly corrosive.
- **Do not** place articles on or against this appliance
- This dryer is not to be used in the presence of dry cleaning solvents.
- A clothes dryer produces combustible lint and the area around the clothes dryer should be kept free of lint.

# Safety Precautions



## Safety Precautions



**Do not dry unwashed items in the machine**

**The machine is not to be used if industrial chemicals have been used for cleaning.**

**Do not allow minors to use the machine.**

**Do not hose down the machine with water.**

**The machine's door lock must under no circumstances be bypassed.**

**Items that have been soiled with substances such as cooking oil, acetone, alcohol, petrol, kerosene, spot removers, turpentine, waxes and wax removers should be washed in hot water with an extra amount of detergent before being dried in the machine.**

**Items such as foam rubber (latex foam), shower caps, waterproof textiles, rubber backed articles and clothes or pillows fitted with foam rubber pads should not be dried in the machine.**

**Fabric softeners or similar products should be used as specified by the fabric softener instructions.**

**The machine may not be used to dry floor mops that contain polypropylene.**

**The final part of a drying cycle occurs without heat (cool down cycle) to ensure that the items are left at a temperature that ensures that the items will not be damaged.**

**WARNING. Never stop the machine before the end of the drying cycle unless all items are quickly removed and spread out so that the heat is dissipated.**

**Remove garments from the machine as soon as they are dried. This prevents them from becoming creased and reduces the risk of spontaneous ignition.**

**If the machine develops a fault, this must be reported to the person in charge as soon as possible. This is important both for your safety and that of others.**

**The machine must not be located where a door, sliding door, etc., can block the machine's door**

**The machine is not intended to be used by people (including minors) with reduced physical or mental capacity or lack of experience and knowledge. Such people must be instructed in the use of the machine by a person who has responsibility for their safety. Minors must be supervised to ensure that they do not play with the machine.**

**Adequate ventilation has to be provided to avoid the back flow of gases into the room for appliances burning other fuels, including open fires.**

**Gas heated tumble dryer:**

**The machine is not to be installed in rooms containing cleaning machines with perchloroethylene, TRICHLOROETHYLENE or CHLOROFLUOROCONTAINING HYDROCARBONS as cleaning agents.**

**If you can smell gas,**

- **Do not switch on any equipment**
- **Do not use electrical switches**
- **Do not use telephones in the building**
- **Evacuate the room, building or area**
- **Contact the person responsible for the machine**



**In order to prevent damage to the electronics (and other parts) that may occur as the result of condensation, the machine should be placed in room temperature for 24 hours before being used for the first time.**



## Instructions for use

### Glossary

#### Auto Stop

The tumble dryer stops automatically when the clothes are dry.

#### AHL (Apartment House Laudry)

Example: Communal laundries / Housing block laundries.

#### OPL (On Premises Laudry)

Example: Institutional laundries.

#### RMC (Residual Moisture Control)

The tumble dryer has residual moisture control.

## Diagram of tumble dryer

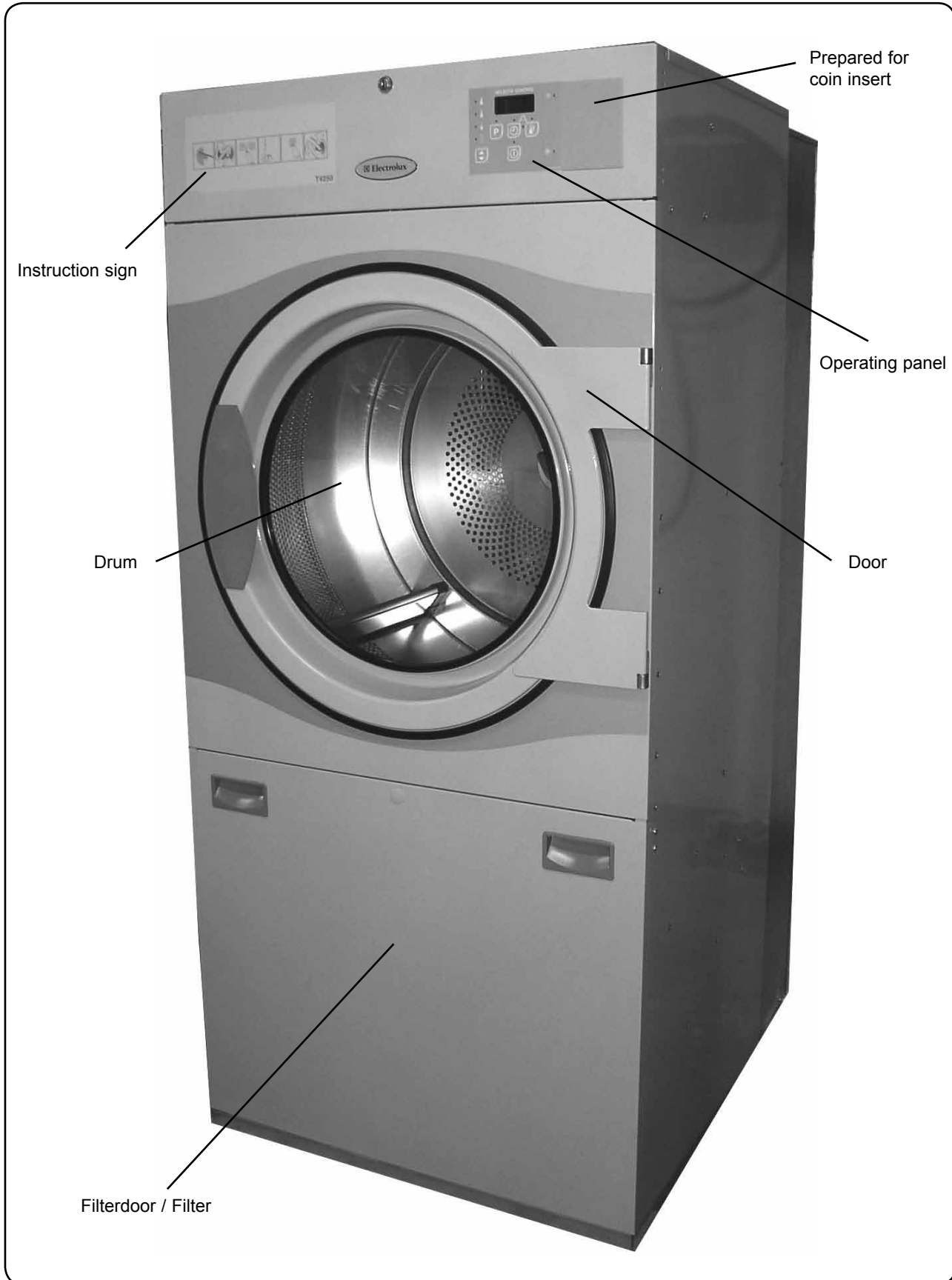



## Instruction signs / operating panels

### AHL - Tumble dryer with manual operation



### OPL - Tumble dryer with manual operation

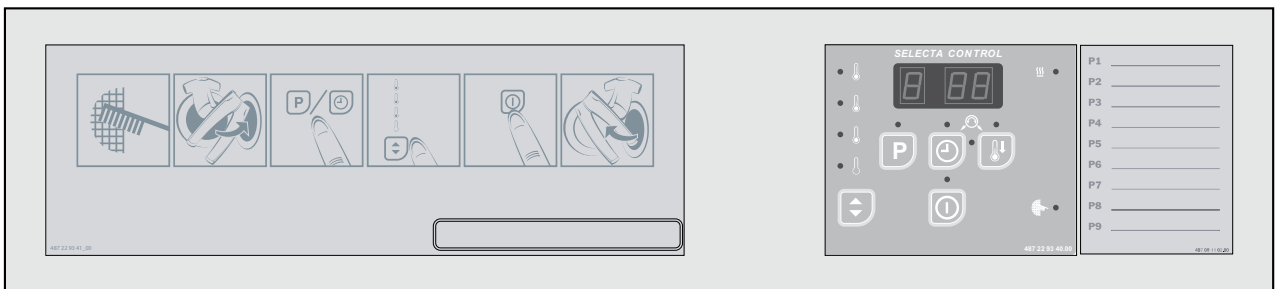







### Coin-operated laundries



W00089

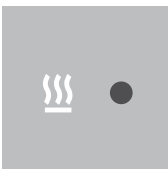
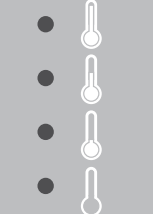
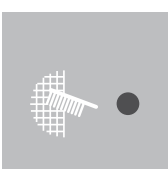

Operating panel - buttons and symbols

	<p><b>P button</b></p> <p>Program selection button. Not active on pay machines.</p> <p>With RMC: Push button during operation, display shows: the residual moisture in the clothes.</p>		<p><b>Reversing</b></p> <p>Reversing on/off. OPL laundries only.</p>
	<p><b>Time button</b></p> <p>Setting of drying time. Not active on pay machines.</p>		<p><b>Cool-down time</b></p> <p>Setting of cool-down time. OPL laundries only.</p>
	<p><b>Temperature button</b></p> <p>Temperature selection button.</p> <p>Push button during operation, display shows: the outlet temperature.</p>		<p><b>Heat</b></p> <p>When lamp is lit the heat is on.</p>
	<p><b>Selected temperature</b></p> <p>Lamp is lit at selected temperature.</p>		<p><b>Filter</b></p> <p>When lamp is lit filter door / filter drawer is open.</p>
	<p><b>Start/stop button</b></p> <p>Start: Push button.</p> <p>Stop: Push button or open door.</p>		
	<p><b>Program status</b></p> <p>“d xx” = Time controlled drying - xx indicates the time.          “c xx” = Time controlled cool-down - xx indicates the time.          “c - -” = Temperature controlled cool-down.          “ 00” = Standby. The dryer runs an anti-crease program for 120 minutes or until the door is opened.</p>		

## Programmes - AHL

### Programmes P 01 - P 02

Program	Process	Textiles
P 01	Extra dry	Denim
P 02	Ready to put away	100% cotton / poly cotton mixture / terry

### Programmes P 01 - P 03 on dryers with RMC

Program	Process	Textiles
P 01	Extra dry	Denim
P 02	Ready to put away	100% cotton / poly cotton mixture / terry
P 03	Ironing dry (15% moisture)	All textiles

### Temperature

<b>High</b>	Non-iron/normal wash	Cotton and mixed fabrics
<b>Medium</b>	Non-iron/normal wash	Cotton and mixed fabrics
<b>Low</b>	Fine wash/mild wash	Delicate fabrics
<b>No heat</b>		Airing bedspreads, duvets and bedclothes

### Load

Full loads are recommended in order to achieve the best result.

Full load is indicated in kilos of dry textile.

Dryer T4250 = 12.5 kg

Dryer T4350 = 17.5 kg

**Tumble dryer with manual operation - AHL**

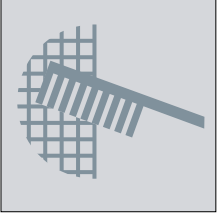
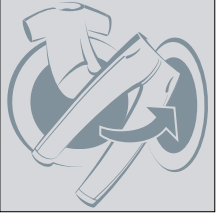
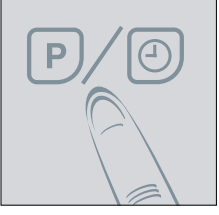
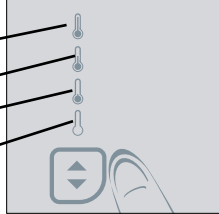
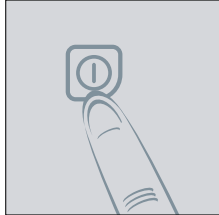
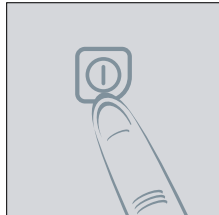
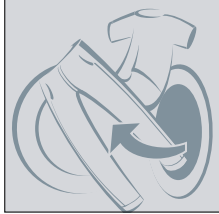
<p><b>1</b></p>	<p><b>Clean filter</b></p> 	<p><b>Fill garments into the drum</b></p>  <p><b>Close the door</b></p>
<p><b>2</b></p>	<p><b>Select programme</b> or <b>set the drying time</b></p> 	<p><b>P 01</b> Extra dry <b>P 02</b> Ready to put away <b>P 03</b> Ironing dry (15% moisture)</p>
<p><b>3</b></p>	<p><b>Select temperature</b></p> <p>High ———— Medium ———— Low ———— No heat ————</p> 	
<p><b>4</b></p>	<p><b>Press start</b></p> 	<p><b>The tumble dryer stops</b></p> <p>Automatically when the clothes are dry or when the selected time has expired.</p>
<p><b>5</b></p>	<p>Wait for the dryer to stop or press stop.</p> 	<p><b>Restart</b></p> <p>Close the door and press start.</p>
<p><b>6</b></p>	<p><b>To prevent creasing:</b> Empty the tumble dryer as soon as the program has ended.</p> 	<p>If the tumble dryer is not emptied immediately after the drying time has ended, an anti-crease programme is automatically engaged. This means that the drum rotates at short intervals, thereby almost completely avoiding creasing.</p>

## Programmes - OPL

### Programmes P 01 - P 09 on dryers with RMC

Program	Process	Textiles
P 01	Extra dry	Denim
P 02	Ready to put away	100% cotton / poly cotton mixture / terry
P 03	Ironing dry (5% moisture)	Polyester / nylon
P 04	Ironing dry (10% moisture)	Wool / silk
P 05	Ironing dry (15% moisture)	Viscose / acetate
P 06	Ironing dry (20% moisture)	Mixed textiles
P 07	10 min. drying	All textiles
P 08	20 min. drying	All textiles
P 09	30 min drying	All textiles

### Programmes P 01 - P 05 on dryers with Auto Stop

Program	Process	Textiles
P 01	Extra dry	All textiles
P 02	Dry	All textiles
P 03	10 min. drying	All textiles
P 04	20 min. drying	All textiles
P 05	30 min drying	All textiles

### Temperature

<b>High</b>	Non-iron/normal wash	Cotton and mixed fabrics
<b>Medium</b>	Non-iron/normal wash	Cotton and mixed fabrics
<b>Low</b>	Fine wash/mild wash	Delicate fabrics,
<b>No heat</b>		Airing bedspreads, duvets and bedclothes

### Load



Full loads are recommended in order to achieve the best result.

Full load is indicated in kilos of dry textile.

Dryer T4250 = 12.5 kg

Dryer T4350 = 17.5 kg

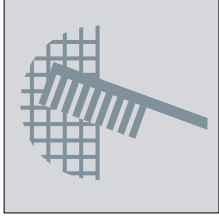
**Tumble dryer with manual operation - OPL**

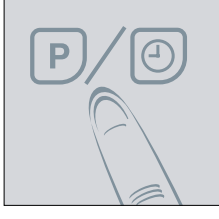
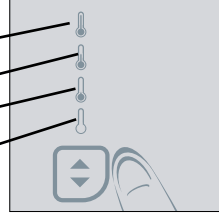
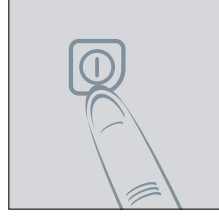
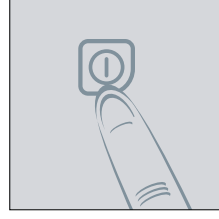
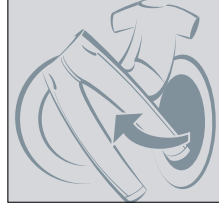
<p><b>1</b></p>	<p><b>Clean filter</b></p> 	<p><b>Fill garments into the drum</b></p>  <p><b>Close the door</b></p>
<p><b>2</b></p>	<p><b>Select programme</b> or <b>set the drying time</b></p> 	<p><b>P 01</b> Extra dry  <b>P 02</b> Ready to put away  <b>P 03</b> Ironing dry (5% moisture)  <b>P 04</b> Ironing dry (10% moisture)  <b>P 05</b> Ironing dry (15% moisture)  <b>P 06</b> Ironing dry (20% moisture)  <b>P 07</b> 10 min. drying  <b>P 08</b> 20 min. drying  <b>P 09</b> 30 min. drying</p>
<p><b>3</b></p>	<p><b>Select temperature</b></p> <p>High Medium Low No heat</p> 	
<p><b>4</b></p>	<p><b>Press start</b></p> 	<p><b>The tumble dryer stops</b></p> <p>Automatically when the clothes are dry or when the selected time has expired.</p>
<p><b>5</b></p>	<p>Wait for the dryer to stop or press stop.</p> 	<p><b>Restart</b></p> <p>Close the door and press start.</p>
<p><b>6</b></p>	<p><b>To prevent creasing:</b> Empty the tumble dryer as soon as the program has ended.</p> 	<p>If the tumble dryer is not emptied immediately after the drying time has ended, an anti-crease programme is automatically engaged. This means that the drum rotates at short intervals, thereby almost completely avoiding creasing.</p>

**Programmes - Coin-operated laundries****Temperature**

<b>High</b>	Non-iron/normal wash	Cotton and mixed fabrics
<b>Medium</b>	Non-iron/normal wash	Cotton and mixed fabrics
<b>Low</b>	Fine wash/mild wash	Delicate fabrics,
<b>No heat</b>		Airing bedspreads, duvets and bedclothes

**Load**

Full loads are recommended in order to achieve the best result.



Full load is indicated in kilos of dry textile.

Dryer T4250 = 12.5 kg

Dryer T4350 = 17.5 kg

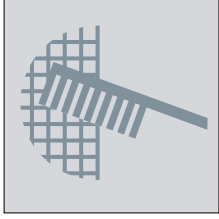

**Tumble dryer with payment**

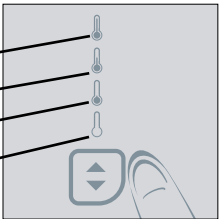
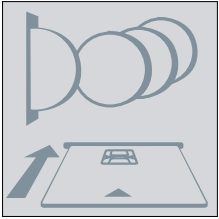
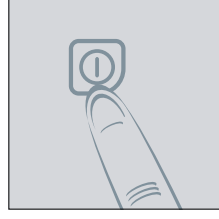
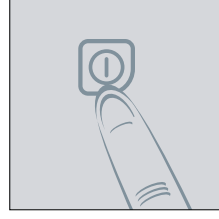
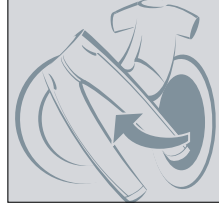
<p><b>1</b></p>	<p><b>Clean filter</b></p> 	<p><b>Fill garments into the drum</b></p>  <p><b>Close the door</b></p>
<p><b>2</b></p>	<p><b>Select temperature</b></p> <p>High</p> <p>Medium</p> <p>Low</p> <p>No heat</p> 	
<p><b>3</b></p>	<p><b>Pay with coins/card</b></p> 	
<p><b>4</b></p>	<p><b>Press start</b></p> 	
<p><b>5</b></p>	<p>Wait for the dryer to stop or press stop.</p> 	
<p><b>6</b></p>	<p><b>To prevent creasing:</b> Empty the tumble dryer as soon as the program has ended.</p> 	<p>If the tumble dryer is not emptied immediately after the drying time has ended, an anti-crease programme is automatically engaged. This means that the drum rotates at short intervals, thereby almost completely avoiding creasing.</p>



### **Error codes**

The tumble dryer has automatic error indication.

Error indication is displayed as a flashing code.

Please refer to the manual Selecta Control for an explanation of error codes.

The inspector of the laundry must be contacted should an error be displayed.

The user can, however, try to correct some error codes himself.

### **Error code E05 or E06**

When the error code E05 or E06 is displayed, this can be due to the motor being too hot.

Stop the dryer and wait for 5 minutes. Start again and choose a program. If this does not help and the error code reappears the inspector of the laundry must be contacted.

### **Error code E12**

When the error code is displayed this can be due to the user having overfilled the dryer with clothes that are too wet.

Remove some of the clothes, close the door, and press the start button. If this does not help and the error code reappears the inspector of the laundry must be contacted.

## Error codes

### Error code E14

When the ignition control fails to detect a flame, a signal is sent to the PCB, and error code E14 is displayed.

When this condition occurs, the gas valve is shut off and the ignition control must be reset manually.

### Resetting

- ① Open the operating panel and press the gas reset button **A** on the back of the PCB for one second.
- ② OPL: Press the reset button **B** next to the operating panel.

**NOTE! When resetting the system the dryer must operate on a program with heat and the heat indicator must be on.**

Japan only: By opening and closing the door (coin operated dryers only).

### Error code

It is normal that error code E14 occurs when first starting up the dryer, since air in the gas line must be purged.

Check that air supply to the room and ventilation are compliant with the recommendations given in the installation manual.

If the problem persists, refer to Error code 14 in the Selecta Control service manual for more information.

1

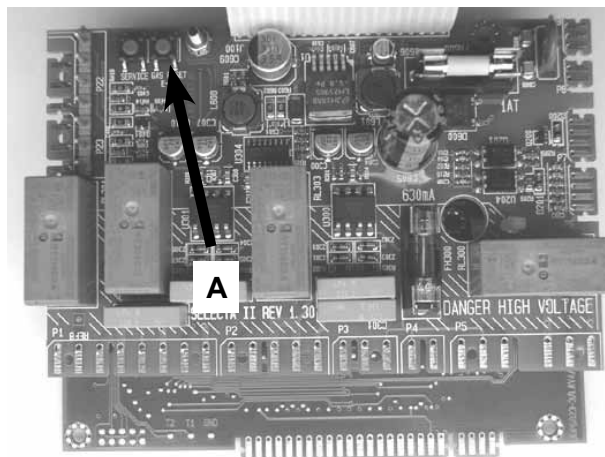

2



### **Error code E15**

When the error code is displayed this can be due to the user having overfilled the dryer.

Remove some of the clothes, close the door, and press the start button. If this does not help and the error code reappears the inspector of the laundry must be contacted.

### **Error code E16**

The error code is displayed if the user presses the start button while the vacuum switch is already closed.

Resetting by opening / closing the door and pressing start button.



## Maintenance

The following should be carried out at regular intervals, depending on the operating frequency.

### Daily

- Check that the drum stops when the loading door or the filter door is opened.  
If the dryer operates with the loading door or filter door open, the machine **must** be placed out of order until repairs are made.  
**NOTE** Contact qualified service personnel to disconnect power from the affected dryer.
- Check that the dryer does not start until the start / stop button is activated.
- Check whether the door packing has been cleaned (use a moist cloth).
- Cleaning of filter compartment.  
Remove the door by opening it and pulling it upwards. It is not necessary to remove the lint filter for cleaning. The air system of the machine ensures that lint and dust settle automatically at the bottom of the filter compartment, from where they are removed by means of a hand-held broom or a vacuum-cleaner.
- Check that the lint filter is unbroken

①

②

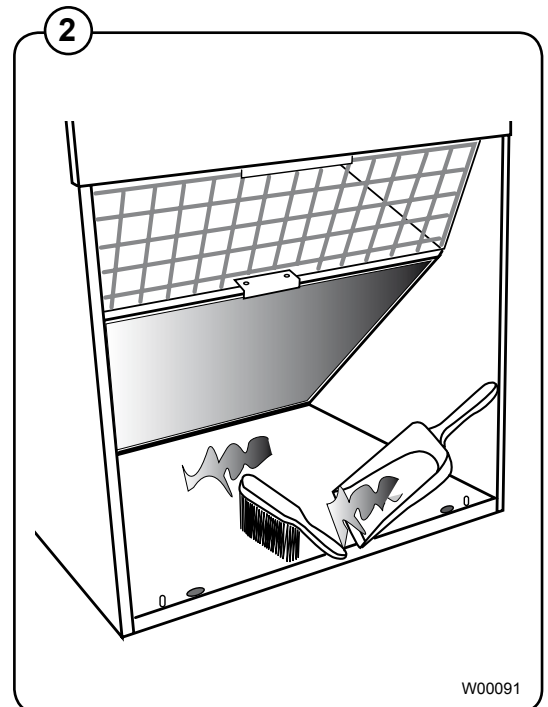
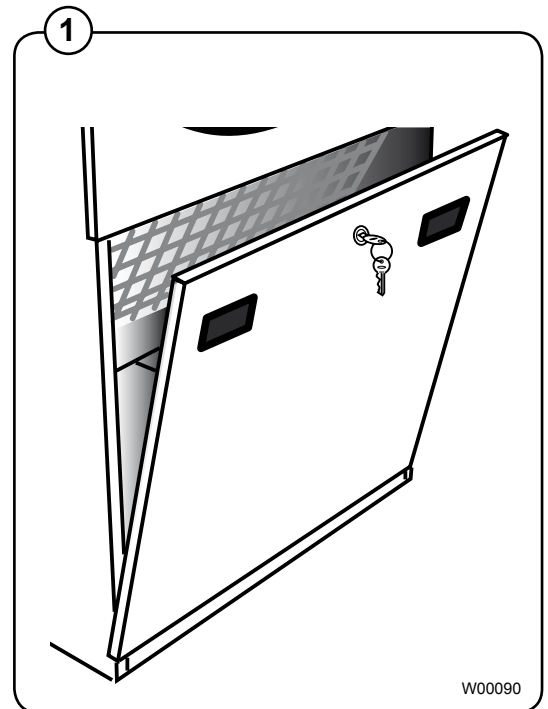

## Weekly

- **Cleaning of filter. Steam heated dryers only**

The filter at the back of the calorifier must be cleaned depending on the depending frequency of use.

It is recommended to clean the filter at least once a week.

The filter must be cleaned with a vacuum cleaner or, if necessary, cleaned with water.

Demount the filter if it needs to be cleaned with water.

After cleaning, replace the filter.

## Monthly

### **Dryer with RMC**

Wipe off/clean drum and lifters with citric acid (*Acidum citricum*). If soap/softener residue remains, it is recommended also to use a coarse sponge.

Lack of cleaning the lifters can reduce the automatic residual moisture control in the clothes resulting in the clothes being moister than requested when the program has ended

## Quarterly

Check that the following are not clogged by lint and dust or otherwise blocked:

- Fresh-air intake on the back of the dryer
- The area surrounding the dryer
- Exhaust duct
- Fresh-air intake to the room

Check that the exhaust system connections are tight.





**To be carried out by qualified personnel**

Disconnect the power to the dryer.

## Annually

- ③ • Dismount front panel and finger protector.  
Clean for lint/dust.  
Check and tighten the support rollers.
- At least once a year, the inside wearing parts should be checked and cleaned for lint.

## Quarterly/Semi-annually

- ④ • Check that the fan wheel is not clogged by lint or otherwise blocked.

## Lubrication

All bearings are maintenance free as they are permanently lubricated.

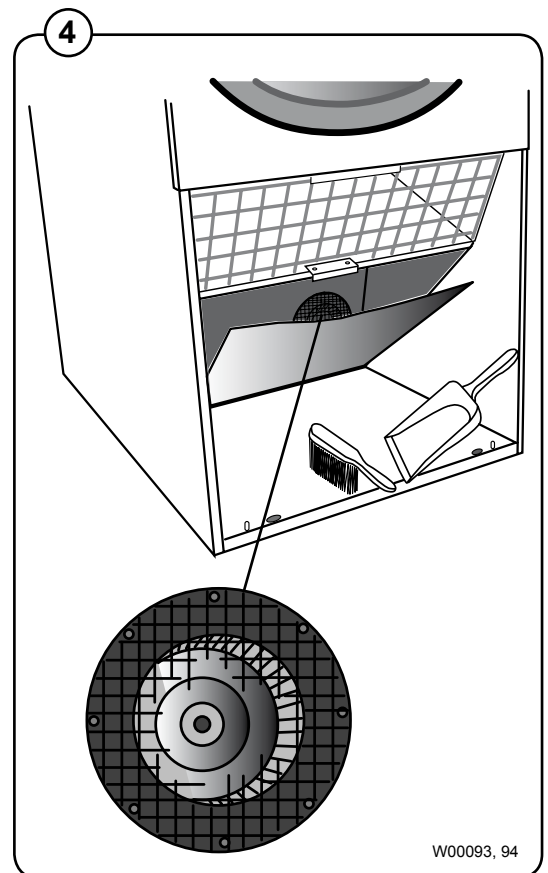
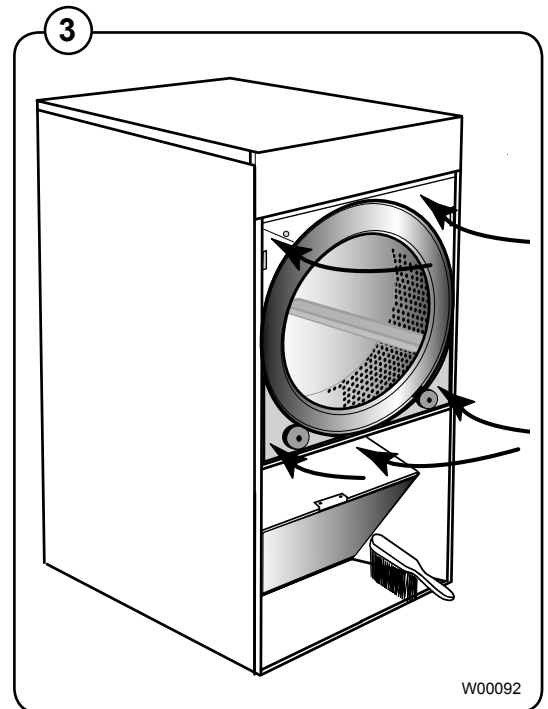



# Washer extractors, Tumble dryers, Hydro extractors

**Types:** W.55H., W3..., WN3..., W4.H., EXSM.X., H1..., N1130., N1190., N2..., N3..., N4..., N5...

**Product standards:** EN 60335-2-4, -7, -11

**EMF standards:** EN 50366:2003 + A1

**EMC standards:** EN 61000-6-1 (2001) W.55H., W3..., W4.H., N1130, N1190, N2..., N3...  
EN 61000-6-3 (2001) W.55H., W3..., WN3..., W4.H., EXSM.X., N1130, N1190, N2..., N3...  
A11 (2003) WN3..., N5...  
EN 61000-3-11 (2001) EXSM.X.  
EN 61000-6-2 (2005) WN3..., N4..., N5...  
EN 61000-6-3 (2007) N4...

## Försäkran om överensstämmelse

Vi, Electrolux Laundry Systems Sweden AB  
SE-341 80 Ljungby, Sverige

försäkrar under eget ansvar att denna produkt, med typbeteckning och enl. ovan, är tillverkad i överensstämmelse med följande direktiv:

- LVD Directive 2006/95/EC
- EMC Directive 2004/108/EC
- GAS Directive 90/396/EEC (gäller endast N'''''' och WN3...)
- CE Marking Directive 93/68/EEC
- RoHS Directive 2002/95/EC
- WEEE Directive 2002/96/EC
- MD Directive 2006/42/EC

## CE Declaration of conformity

We, Electrolux Laundry Systems Sweden AB  
SE-341 80 Ljungby, Sweden

declare under our sole responsibility that the product of the type stated above is manufactured in conformity with the following EU directives:

- LVD Directive 2006/95/EC
- EMC Directive 2004/108/EC
- GAS Directive 90/396/EEC (N''''''... and WN3... only)
- CE Marking Directive 93/68/EEC
- RoHS Directive 2002/95/EC
- WEEE Directive 2002/96/EC
- MD Directive 2006/42/EC

## EG-Konformitätserklärung

Wir, die, Electrolux Laundry Systems Sweden AB  
SE-341 80 Ljungby, Schweden

erklären hiermit in alleiniger Verantwortung, daß das Produkt mit der oben genannten Typenbezeichnung mit folgenden EU-Richtlinien übereinstimmt:

- LVD Directive 2006/95/EC
- EMC Directive 2004/108/EC
- GAS Directive 90/396/EEC (Nur N'''''' und WN3...)
- CE Marking Directive 93/68/EEC
- RoHS Directive 2002/95/EC
- WEEE Directive 2002/96/EC
- MD Directive 2006/42/EC

## Déclaration de conformité CE

Nous, Electrolux Laundry Systems Sweden AB  
SE-341 80 Ljungby, Suède

déclarons sous notre seule et unique responsabilité que le produit des type et numéro de série indiqués ci-dessus est fabriqué conformément aux directives UE suivantes:

- LVD Directive 2006/95/EC
- EMC Directive 2004/108/EC
- GAS Directive 90/396/EEC (N'''''' et WN3... uniquement)
- CE Marking Directive 93/68/EEC
- RoHS Directive 2002/95/EC
- WEEE Directive 2002/96/EC
- MD Directive 2006/42/EC

## Declaración de conformidad CE

Electrolux Laundry Systems Sweden AB  
con sede en SE-341 80 Ljungby, Suecia

declara bajo su exclusiva responsabilidad que el producto cuyo tipo se especifica en el encabezado se ha fabricado conforme a las siguientes directivas:

- LVD Directive 2006/95/EC
- EMC Directive 2004/108/EC
- GAS Directive 90/396/EEC (vale sólo N'''''' y WN3)
- CE Marking Directive 93/68/EEC
- RoHS Directive 2002/95/EC
- WEEE Directive 2002/96/EC
- MD Directive 2006/42/EC

## Erklæring om EU-overensstemmelse

Vi, Electrolux Laundry Systems Sweden AB  
SE-341 80 Ljungby, Sverige

erklærer på eget ansvar, at produktet med typebetegnelse som angivet er fremstillet i overensstemmelse med følgende EU-direktiver:

- LVD Directive 2006/95/EC
- EMC Directive 2004/108/EC
- GAS Directive 90/396/EEC (gælder kun N'''''' og WN3...)
- CE Marking Directive 93/68/EEC
- RoHS Directive 2002/95/EC
- WEEE Directive 2002/96/EC
- MD Directive 2006/42/EC

## EY-Vaatimustenmukaisuusvakuutus

Me, Electrolux Laundry Systems Sweden AB  
SE-341 80 Ljungby, Ruotsi

vakuutamme yksinomaan omalla vastuullamme, että tuote, jonka tyyppitunnus lukee yllä, on valmistettu seuraavien [EU]-direktiivien mukaisesti:

- LVD Directive 2006/95/EC
- EMC Directive 2004/108/EC
- GAS Directive 90/396/EEC (vain N'''''' ja WN3...)
- CE Marking Directive 93/68/EEC
- RoHS Directive 2002/95/EC
- WEEE Directive 2002/96/EC
- MD Directive 2006/42/EC

## EF-samsvarserklæring

Vi, Electrolux Laundry Systems Sweden AB  
SE-341 80 Ljungby, Sverige,

erklærer på eget ansvar at dette produktet, med typebetegnelse og produktionsnummer som angitt nedenfor, er produsert i samsvar med bestemmelsene i følgende direktiver:

- LVD Directive 2006/95/EC
- EMC Directive 2004/108/EC
- GAS Directive 90/396/EEC (gjelder bare N'''''' og WN3...)
- CE Marking Directive 93/68/EEC
- RoHS Directive 2002/95/EC
- WEEE Directive 2002/96/EC
- MD Directive 2006/42/EC

## EG-Conformiteitsverklaring

Wij, Electrolux Laundry Systems Sweden AB  
SE-341 80 Ljungby, Zweden

verklaaren hierbij op eigen verantwoordelijkheid dat het product van het type en met het serienummer zoals hieronder vermeld, is vervaardigd conform de volgende normen:

- LVD Directive 2006/95/EC
- EMC Directive 2004/108/EC
- GAS Directive 90/396/EEC (alleen N'''''' en WN3...)
- CE Marking Directive 93/68/EEC
- RoHS Directive 2002/95/EC
- WEEE Directive 2002/96/EC
- MD Directive 2006/42/EC

## Dichiarazione CE di conformità

Noi, Electrolux Laundry Systems Sweden AB  
SE-341 80 Ljungby, Svezia

dichiariamo sotto la nostra intera responsabilità che il prodotto del tipo specificato sopra è conforme alle seguenti direttive [UE]:

- LVD Directive 2006/95/EC
- EMC Directive 2004/108/EC
- GAS Directive 90/396/EEC (solo N'''''' e WN3...)
- CE Marking Directive 93/68/EEC
- RoHS Directive 2002/95/EC
- WEEE Directive 2002/96/EC
- MD Directive 2006/42/EC

## Declaração CE de conformidade

Nós, Electrolux Laundry Systems Sweden AB  
SE-341 80 Ljungby, Suécia

declaramos sob nossa inteira responsabilidade que o produto com os números de série e de tipo abaixo indicados é fabricado em conformidade com as seguintes diretivas [UE]:

- LVD Directive 2006/95/EC
- EMC Directive 2004/108/EC
- GAS Directive 90/396/EEC (apenas N'''''' e WN3...)
- CE Marking Directive 93/68/EEC
- RoHS Directive 2002/95/EC
- WEEE Directive 2002/96/EC
- MD Directive 2006/42/EC

## ΔΗΛΩΣΗ ΠΙΣΤΟΤΗΤΑΣ ΕΚ

H, Electrolux Laundry Systems Sweden AB  
SE-341 80 Ljungby, Σουηδία

δηλώνει με αποκλειστική της ευθύνη ότι το προϊόν του ανωτέρω αναφερόμενου τύπου κατασκευάζεται σύμφωνα με τις ακόλουθες οδηγίες της Ευρωπαϊκής Ένωσης:

- LVD Directive 2006/95/EC
- EMC Directive 2004/108/EC
- GAS Directive 90/396/EEC (N'''''' και WN3... μόνο)
- CE Marking Directive 93/68/EEC
- RoHS Directive 2002/95/EC
- WEEE Directive 2002/96/EC
- MD Directive 2006/42/EC

## CE megfeleléségi nyilatkozat

Mi, az, Electrolux Laundry Systems Sweden AB  
SE-341 8 Ljungby, Svédország

felelőségünk teljes tudatában kijelentjük, hogy az alább megadott típusú termék gyártása a következő EU-irányelvekkel összhangban történik:

- LVD Directive 2006/95/EC
- EMC Directive 2004/108/EC
- GAS Directive 90/396/EEC (csak az N'''''' és WN3... esetén)
- CE Marking Directive 93/68/EEC
- RoHS Directive 2002/95/EC
- WEEE Directive 2002/96/EC
- MD Directive 2006/42/EC

Ljungby 2010.03.15

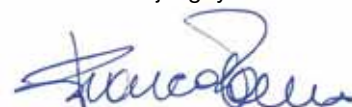

**Franco Panno**  
Vice President Technical Operations

471 1531-43/20

Page 1/2

**Translation table for model name to type of approval**

Commercial name	Type
W455H	W.55H.
W465H	W3...
W475H	W3...
W4105H	W3...
W4130H	W3...
W4180H	W3...
W4240H	W3...
W4300H	W3...
FOM71 CLS	W3...
WB4130H	W3...
WB4180H	W3...
PW9	W3...
W475S	W3...
W485S	W3...
W4105S	W3...
W4130S	W3...
W4180S	W3...
W4250S	W3...
W4330S	W3...
W475N	W3...
W485N	W3...
W4105N	W3...
W4130N	W3...
W4180N	W3...
W4250N	W3...
W4330N	W3...
WD4130H	WN3...
WD4240H	WN3...
W4400H	W4.H.
W4600H	W4.H.
W4850H	W4.H.
W41100H	W4.H.
W4280X	EXSM.X.
W4350X	EXSM.X.
W4600X	EXSM.X.
C240	H1...
C260	H1...
C240R	H1...
C260R	H1...
C290R	H1...
T4130	N1130..
T4190	N1190..
PD9	N1190..
T4250	N2...
T4350	N2...
T4300S	N3...
T4290	N4...
T4530	N4...
T4650	N4...
T4900	N4...
T41200	N4...
T4900CR	N4...
T41200CR	N4...
T4300LE	N5...

Ljungby 2010.03.15

**Franco Panno**  
 Vice President Technical Operations



#### Skrotning av maskin

När maskinen inte längre skall användas måste den lämnas till en återvinningsstation för destruktion. Många detaljer i maskinen går att återanvända, men den innehåller även annat material som måste tas om hand på ett korrekt sätt. Lämna därför aldrig maskinen eller delar av maskinen i hushållsavfallet, eftersom det kan leda till hälsorisker eller skador på miljön.

#### Scrapping of machine

When the machine is no longer to be used, it must be submitted to a recycling facility for destruction. The majority of the components in the machine can be reused, but it also contains other material that must be taken care of in the correct way. Therefore, never mix the machine or its parts with domestic waste as this may lead to health hazards or damage to the environment.

#### Entsorgung des Geräts

Wenn das Gerät nicht länger im Gebrauch ist, muss dieses einer Recyclingstation zur Entsorgung zugeführt werden. Viele Komponenten des Geräts sind recyclingfähig, enthalten aber auch Materialien, die vorschriftsmäßig entsorgt werden müssen. Entsorgen Sie daher das Gerät oder Geräteteile niemals im Hausmüll, da dies Gefahren für die Gesundheit oder Umweltschäden nach sich ziehen kann.

#### Mise au rebut de machine

Lorsque la machine n'est plus utilisée, elle doit être déposée à une installation de recyclage pour y être détruite. La majorité des composants de la machine peuvent être réutilisés mais celle-ci contient également d'autres matériaux qui doivent être traités correctement. C'est pourquoi vous ne devez jamais mélanger la machine ou ses pièces avec les ordures ménagères, risque de pollution pour l'environnement ou la santé.

#### Desguace de la máquina

Cuando la máquina no tenga que utilizarse más, ha de entregarse a una instalación de destrucción para su reciclado. La mayor parte de sus componentes pueden volver a utilizarse, pero consta también de otros materiales que han de ser tratados de la manera correcta. Por esa razón nunca mezclar la máquina ni sus partes con la basura doméstica pues esto podría constituir un peligro para la salud o dañar el medio ambiente.

#### Bortskaffelse af maskinen

Når maskinen ikke længere er i brug, skal den afleveres til destruktion på en genbrugsstation. Mange dele i maskinen kan genanvendes, men den indeholder også andre materialer, der skal håndteres korrekt. Smid derfor ikke maskinen eller dele af den ud sammen med husholdningens almindelige affald, da det kan være forbundet med sundhedsrisiko eller give miljøskader.

#### Koneen hävittäminen

Kun koneita ei enää käytetä, se pitää luovuttaa kierrätyskeskukseen tuhottavaksi. Suurinta osaa koneen osista voidaan käyttää uudelleen, mutta se sisältää myös materiaaleja, jotka pitää käsitellä asianmukaisesti. Älä sen vuoksi koskaan laita koneita tai sen osia kotitalousjätteen sekaan, sillä se saattaa aiheuttaa terveysriskejä tai vahinkoa ympäristölle.

#### Skrotning av maskin

Når maskinen ikke lenger skal brukes, må den leveres til en gjenvinningsstasjon for destruksjon. Det går an å gjenbruke mange deler av maskinen, men den inneholder også annet materiale som man må ta hånd om på riktig måte. Legg derfor aldri maskinen eller deler av maskinen i husholdningsavfallet, siden det kan føre til helse- eller miljøskader.

#### Afdanken van de machine

Als de machine niet langer gebruikt gaat worden, moet deze ter vernietiging worden aangeboden bij een recyclinginrichting. De meeste componenten van de machine kunnen worden hergebruikt, maar hij bevat ook ander materiaal dat op een juiste wijze moet worden behandeld. Daarom de machine of zijn onderdelen nooit bij het huisvuil zetten, want dat kan leiden tot gezondheidsrisico's of schade aan het milieu.

#### Rottamazione della macchina

Quando la macchina non può più essere utilizzata, deve essere affidata a un centro di riciclaggio che ne effettui la rottamazione. La maggior parte dei componenti della macchina sono riciclabili, ma ce ne sono anche alcuni che devono essere smaltiti in modo appropriato. Perciò, non mischiare mai la macchina o parti di essa con i normali rifiuti domestici, poiché ciò potrebbe comportare rischi per la salute o per l'ambiente.

#### Złomowanie maszyny

Wycofaną z użytkowania maszynę należy przekazać do zakładu utylizacji w celu złomowania. Większość podzespołów maszyny nadaje się do powtórnego wykorzystania, lecz zawiera ona także inne materiały, z którymi należy postępować w odpowiedni sposób. Z tego powodu niedozwolone jest łączenie maszyny lub jej części z odpadami domowymi, gdyż może to prowadzić do zagrożenia zdrowia lub szkody dla środowiska.

#### Vyřazení přístroje

Přístroj, který již nebude používán, by měl být odevzdán k likvidaci do ekodvora. Většina součástí přístroje může být opětovně použita, některé ale vyžadují likvidaci přesně daným způsobem. A proto nikdy nemíchejte dohromady přístroje nebo jejich části s domácím odpadem, mohlo by to vést ke zdravotním rizikům nebo k poškození životního prostředí.

#### Οριστική απόσυρση μηχανήματος

Όταν το μηχάνημα δεν προορίζεται για περαιτέρω χρήση, θα πρέπει να οδηγείται σε εγκατάσταση ανακύκλωσης για καταστροφή. Το μεγαλύτερο ποσοστό των εξαρτημάτων του μηχανήματος μπορεί να χρησιμοποιηθεί ξανά, αλλά το μηχάνημα περιλαμβάνει και άλλα υλικά η διαλογή των οποίων θα πρέπει να πραγματοποιείται με τον κατάλληλο τρόπο. Κατά συνέπεια, μην αναμειγνύετε ποτέ το μηχάνημα ή τα εξαρτήματά του με οικιακά απορρίμματα καθώς αυτό μπορεί να αποβεί επικίνδυνο για την υγεία ή επιβλαβές για το περιβάλλον.





*Thinking of you*

 **Electrolux**

Electrolux Laundry Systems Sweden AB  
341 80 Ljungby, Sweden  
[www.electrolux.com/laundrysystems](http://www.electrolux.com/laundrysystems)

**Share more of our thinking at [www.electrolux.com](http://www.electrolux.com)**