

Operating manual
T4290, T4530, T4650
Selecta Control

487 05 44 31.00
EN



Safety instructions



This machine is only intended for drying water-washed garments.

Clothes that have been cleaned with chemicals/flammable liquids, must NOT be dried in the machine.

Remove clothes from the tumble dryer as soon as they are dry. This prevents them from becoming creased, and reduces the risk of spontaneous ignition.

The machine must not be used for drying foam rubber or foam-like materials.

The machine must not be used for drying floor mops*.

The machine must not be used by minors.

The machine must not be hosed down with water.

Adequate ventilation has to be provided to avoid the back flow of gases into the room from appliances burning other fuels, including open fires.

Mechanical, electrical and gas installations must only be carried out by authorised personnel.

If the machine has a fault, this must be reported as soon as possible to the person in charge. This is important for your own safety and for the safety of others.

Gas dryers only:

The machine is not to be installed in rooms containing cleaning machines with perchloroethylene, TRICHLOROETHYLENE or CHLOROFLUOROCONTAINING HYDROCARBONS as cleaning agents.

What to do if you smell gas:

Do not try to light any appliance.

Do not touch any electrical switch; do not use any phone in your building.

Evacuate the room, building or area.

Contact the laundry manager.

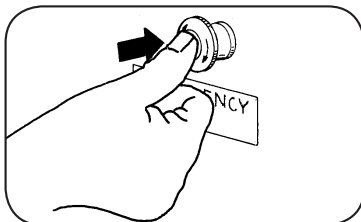

Emergency stop (T4530/4650)

If the machine for some reason has to be stopped – press emergency stop button.

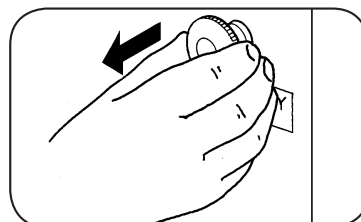

When the necessary measures have been taken, pull out the emergency stop button. (The emergency stop button is an option outside EU and EEA).

* Applies only to floor mops containing polypropylene.

Contents:

Glossary	7
Operating panel	8
Instructions for use	10
Programs AHL	10
Tumble dryer with manual operation - AHL	11
Programs OPL	12
Tumble dryer with manual operation - OPL	13
Programs - coin operated laundries	14
Tumble dryer with payment	15
Error codes	16
Maintenance	17

The manufacturer reserves the right to modify design and material specifications without notice.

**Textiles as silk and wool must not be overdried
to avoid the risk of creasing.**

Glossary

Auto Stop

The tumble dryer stops automatically when the clothes are dry.

AHL (Apartment House Laudry)

Example: Communal laundries / Housing block laundries.

OPL (On Premises Laudry)

Example: Institutional laundries.

RMC (Residual Moisture Control)

The tumble dryer has residual moisture control.

Operating panel

Operating panel

AHL - Tumble dryer with manual operation



OPL - Tumble dryer with manual operation

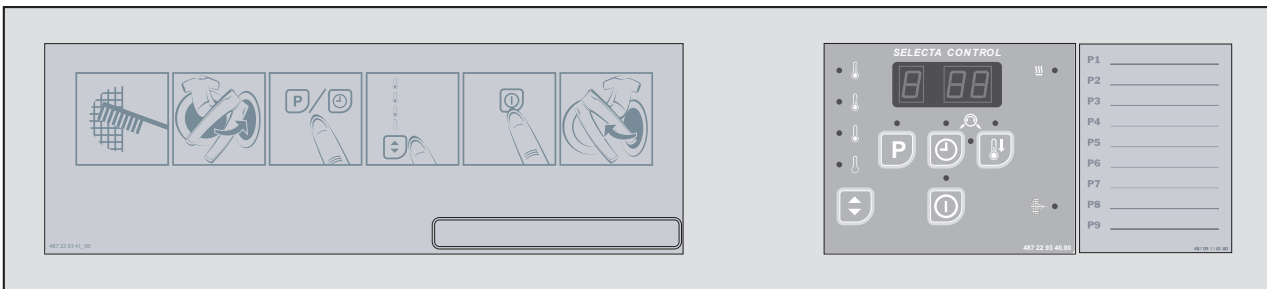

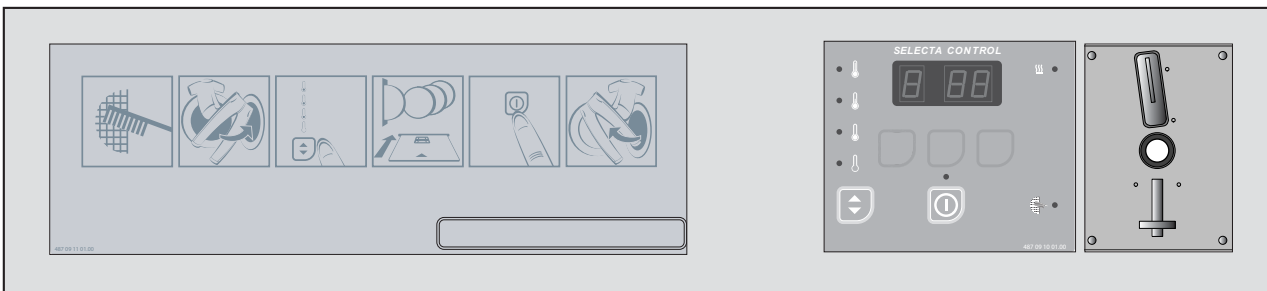

Coin-operated laundries



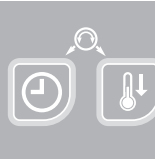

Buttons and symbols

	<p>P button</p> <p>Program selection button. Not active on pay machines.</p> <p>With RMC: Push button during operation, display shows: the residual moisture in the clothes.</p>
---	---

	<p>Reversing</p> <p>Reversing on/off. OPL laundries only.</p>
--	--

	<p>Time button</p> <p>Setting of drying time. Not active on pay machines.</p>
---	--

	<p>Cool-down time</p> <p>Setting of cool-down time. OPL laundries only.</p>
--	--

	<p>Temperature button</p> <p>Temperature selection button.</p> <p>Push button during operation, display shows: the outlet temperature.</p>
---	---

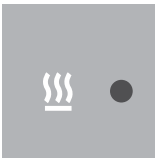
	<p>Heat</p> <p>When lamp is lit the heat is on.</p>
--	--

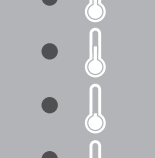
	<p>Selected temperature</p> <p>Lamp is lit at selected temperature.</p>
---	--

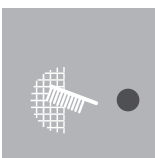
	<p>Filter</p> <p>When lamp is lit filter door / filter drawer is open.</p>
--	---

	<p>Start/stop button</p> <p>Start: Push button.</p> <p>Stop: Push button or open door.</p>
---	---

	<p>Program status</p> <p>“d xx” = Time controlled drying - xx indicates the time. “c xx” = Time controlled cool-down - xx indicates the time. “c - -” = Temperature controlled cool-down. “ 00” = Standby. The dryer runs an anti-crease program for 120 minutes or until the door is opened.</p>
---	---

Programs AHL

Programs P 01 - P 02

Program	Process	Textiles
P 01	Extra dry	Denim
P 02	Ready to put away	100% cotton / poly cotton mixture / terry

Programs P 01 - P 03 on dryers with RMC

Program	Process	Textiles
P 01	Extra dry	Denim
P 02	Ready to put away	100% cotton / poly cotton mixture / terry
P 03	Ironing dry 15% moisture	All textiles

Temperatures

High	Non-iron/normal wash	Cotton and mixed fabrics
Medium	Non-iron/normal wash	Cotton and mixed fabrics
Low	Fine wash/mild wash	Delicate fabrics
No heat		Airing bedspreads, duvets and bedclothes

Load

Full loads are recommended in order to achieve the best result.







Full load is indicated in kilos of dry textile.

Dryer type 4290 = 13,5 kg

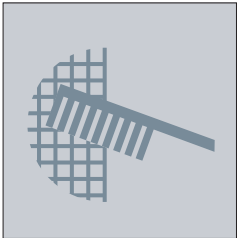
Dryer type 4530 = 27 kg

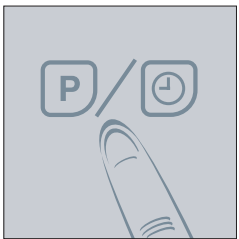
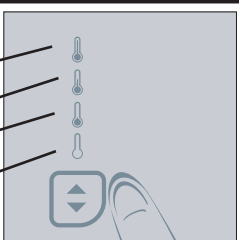
Dryer type 4650 = 35 kg

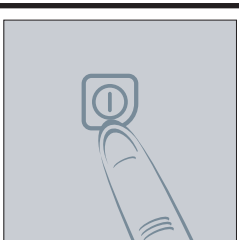
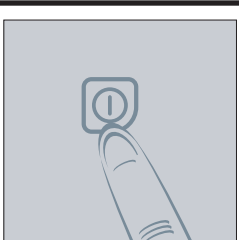
Tumble dryer with manual operation - AHL

<p>1</p>	<p>Clean filter</p>		<p>Fill garments into the drum</p> <p>Close the door</p> 
<p>2</p>	<p>Select programme or set the drying time</p>		<p>P 01 Extra dry</p> <p>P 02 Ready to put away</p> <p>P 03 Ironing dry (15% moisture)</p>
<p>3</p>	<p>Select temperature</p> <p>High</p> <p>Medium</p> <p>Low</p> <p>No heat</p>		<p>The last minutes of the drying time are the cool-down period (cooling of the clothes).</p> 
<p>4</p>	<p>Press start</p>		<p>The tumble dryer stops</p> <p>Automatically when the clothes are dry or when the selected time has expired.</p>
<p>5</p>	<p>Wait for the dryer to stop or press stop.</p>		<p>Restart</p> <p>Close the door and press start.</p>
<p>6</p>	<p>To prevent creasing:</p> <p>Empty the tumble dryer as soon as the program has ended.</p>		<p>If the tumble dryer is not emptied immediately after the drying time has ended, an anti-crease programme is automatically engaged.</p> <p>This means that the drum rotates at short intervals, thereby almost completely avoiding creasing.</p>

Instructions for use

Programs OPL

Programs P 01 - P 09 on dryers with RMC

Program	Process	Textiles
P 01	Extra dry	Denim
P 02	Ready to put away	100% cotton / poly cotton mixture / terry
P 03	Ironing dry (5% moisture)	Polyester / nylon
P 04	Ironing dry (10% moisture)	Wool / silk
P 05	Ironing dry (15% moisture)	Viscose / acetate
P 06	Ironing dry (20% moisture)	Mixed textiles
P 07	10 min drying	All textiles
P 08	20 min drying	All textiles
P 09	30 min drying	All textiles

Programs P 01 - P 05 on dryers with Auto Stop

Program	Process	Textiles
P 01	Extra dry	Denim
P 02	Ready to put away	100% cotton / poly cotton mixture / terry
P 03	10 min drying	All textiles
P 04	20 min drying	All textiles
P 05	30 min drying	All textiles

Temperature

High	Non-iron/normal wash	Cotton and mixed fabrics
Medium	Non-iron/normal wash	Cotton and mixed fabrics
Low	Fine wash/mild wash	Delicate fabrics
No heat		Airing bedspreads, duvets and bedclothes

Load

Full loads are recommended in order to achieve the best result.





Full load is indicated in kilos of dry textile.

Dryer type 4290 = 13,5 kg

Dryer type 4530 = 27 kg

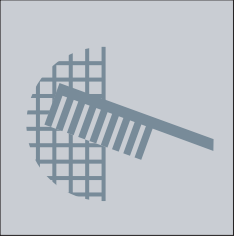
Dryer type 4650 = 35 kg

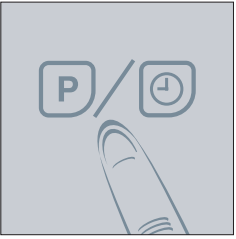
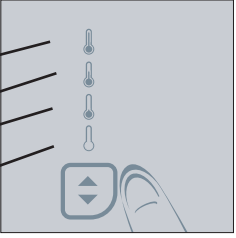
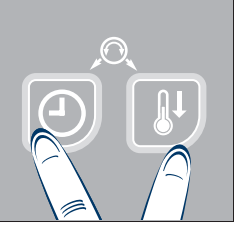
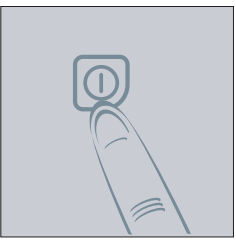
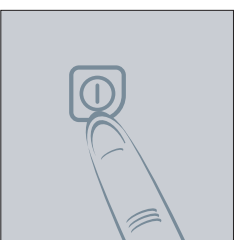
Tumble dryer with manual operation - OPL

<p>1</p>	<p>Clean filter</p>		<p>Fill garments into the drum</p> <p>Close the door</p> 
<p>2</p>	<p>Select programme or set the drying time</p>		<p>P 01 Extra dry P 02 Ready to put away P 03 Ironing dry (5% moisture) P 04 Ironing dry (10% moisture) P 05 Ironing dry (15% moisture) P 06 Ironing dry (20% moisture) P 07 10 min. drying P 08 20 min. drying P 09 30 min. drying</p>
<p>3</p>	<p>Select temperature</p> <p>High Medium Low No heat</p>		<p>Cool-down period: Can be changed.</p> <p>Reversing on / off: Press the clock button and the button for cooling down time at the same time</p> 
<p>4</p>	<p>Press start</p>		<p>The tumble dryer stops</p> <p>Automatically when the clothes are dry or when the selected time has expired.</p>
<p>5</p>	<p>Wait for the dryer to stop or press stop.</p>		<p>Restart</p> <p>Close the door and press start.</p>
<p>6</p>	<p>To prevent creasing: Empty the tumble dryer as soon as the program has ended.</p>		<p>If the tumble dryer is not emptied immediately after the drying time has ended, an anti-crease programme is automatically engaged.</p> <p>This means that the drum rotates at short intervals, thereby almost completely avoiding creasing.</p>

Programs - Coin operated laundries**Temperature**

Program	Process	Textiles
High	Non-iron/normal wash	Cotton and mixed fabrics
Medium	Non-iron/normal wash	Cotton and mixed fabrics
Low	Fine wash/mild wash	Delicate fabrics
No heat		Airing bedspreads, duvets and bedclothes

Load

Full loads are recommended in order to achieve the best result.



Full load is indicated in kilos of dry textile.

Dryer type 4290 = 13,5 kg

Dryer type 4530 = 27 kg

Dryer type 4650 = 35 kg

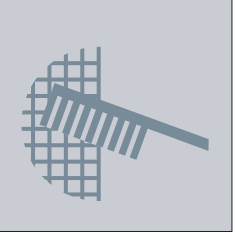
Tumble dryer with payment

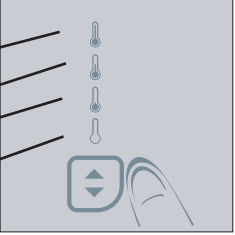
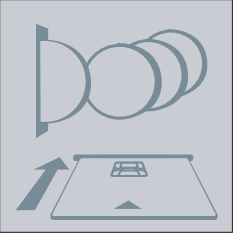
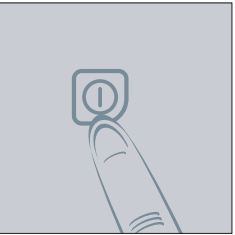
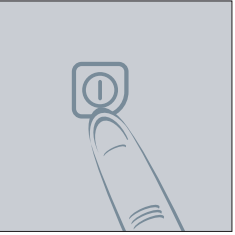
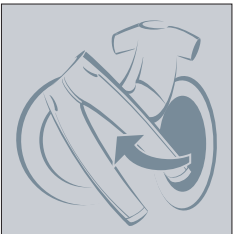
<p>1</p>	<p>Clean filter</p>		<p>Fill garments into the drum Close the door</p>	
<p>2</p>	<p>Select temperature</p> <p>High Medium Low No heat</p>			
<p>3</p>	<p>Pay with coins / card</p>			
<p>4</p>	<p>Press start</p>			
<p>5</p>	<p>Wait for the dryer to stop or press stop.</p>			
<p>6</p>	<p>To prevent creasing: Empty the tumble dryer as soon as the program has ended.</p>		<p>If the tumble dryer is not emptied immediately after the drying time has ended, an anti-crease programme is automatically engaged. This means that the drum rotates at short intervals, thereby almost completely avoiding creasing.</p>	

Error codes

The dryer has automatic error indication.

Error indication is displayed as a flashing code.

Please refer to the Programming manual for Selecta Control for an explanation of error codes.

A service technician must be contacted should an error be displayed.

The user can, however, try to correct some error codes himself.

Error code E05 or E06

When error code E05 or E06 is displayed this can be due to the motor being too hot.

Stop the dryer and wait for 5 minutes. Start again and choose a program. If this does not help and the error code reappears a service technician must be contacted.

Error code E12

When the error code is displayed this can be due to the user having overfilled the dryer.

Remove some of the clothes, close the door, and press the start button. If this does not help and the error code reappears a service technician must be contacted.

Error code E14. OPL laundries only

When resetting gas error **E14** the dryer must be in operation on a program with heat, and the heating indicator must be on.

The dryer must only be reset 3 times.

If the dryer, however, has to be reset more than 3 times it must be put out of order and a service technician must be called.

Error code E15

When the error code is displayed this can be due to the user having overfilled the dryer.

Remove some of the clothes, close the door, and press the start button. If this does not help and the error code reappears a service technician must be contacted.

Error code E16

The error code is displayed if the user presses the start button while the vacuum switch is already closed.

Resetting by opening / closing the door and pressing start button.

Maintenance

The following should be carried out at regular intervals, depending on the operating frequency.

Daily

- Check that the drum stops when the loading door is opened.
- Check that the drum stops when the filter door is opened.

If the dryer operates with the loading door or the filter door open the machine **must** be placed out of order until repairs are made.

NOTE Contact qualified service personnel to disconnect power from the dryer.

- Check that the dryer does not start until the start / stop button is activated.
- Check whether the door gasket has been cleaned (use a moist cloth).
- Cleaning of filter compartment fig 1-2.
Remove the door by opening it and pulling it upwards. It is not necessary to remove the lint filter for cleaning. The air system of the machine ensures that lint and dust settle automatically at the bottom of the filter compartment, from where they are removed by means of a hand-held broom or a vacuum-cleaner.
- Check that the lint filter is unbroken.

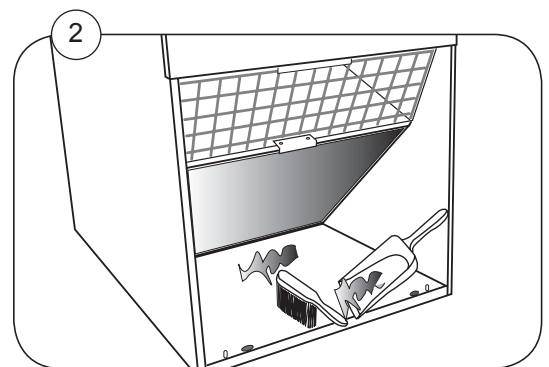
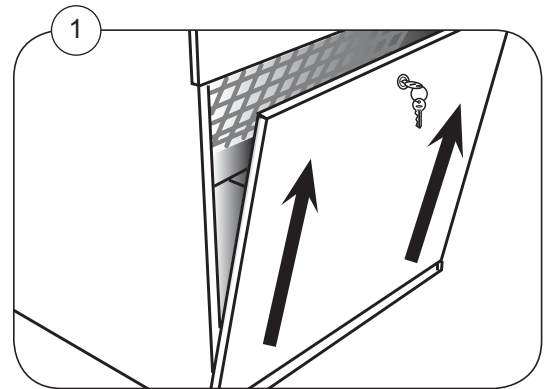

Weekly

Steam heated dryers only

Fig. 1 Cleaning the filter in front of steam calorifier.

1. Open the front panel.
2. Remove the filter as shown (A).
3. Clean the filter with water or with compressed air.
4. Replace the filter and close front panel.

Lubrication

All bearings are maintenance free as they are permanently lubricated.

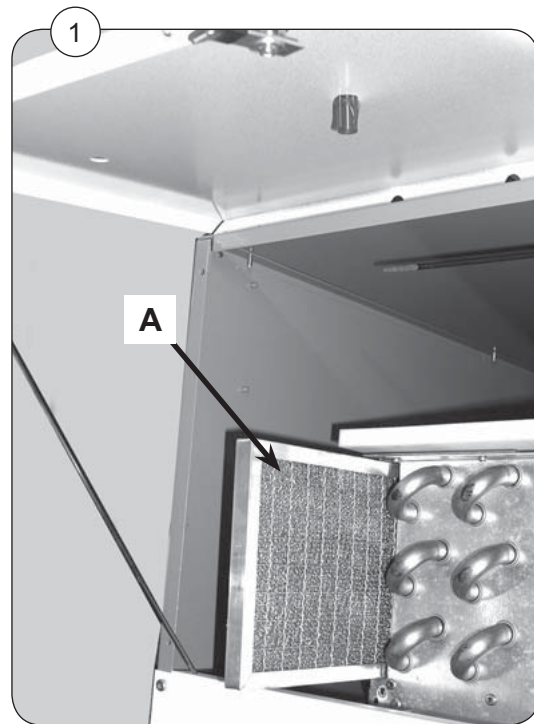

Quarterly

Check that the following are not clogged by lint and dust or otherwise blocked:

- Fresh-air intake on the back of the dryer
- The area surrounding the dryer
- Exhaust duct
- Fresh-air intake to the room

Check that the exhaust system connections are tight.

Dryers with RMC only

Wipe off/clean drum and lifters **A** with citric acid (*Acidum citricum*). If soap/softener residue remains, it is recommended also to use a coarse sponge.

Lack of cleaning the lifters can reduce the automatic residual moisture control in the clothes resulting in the clothes being moister than requested when the program has ended.

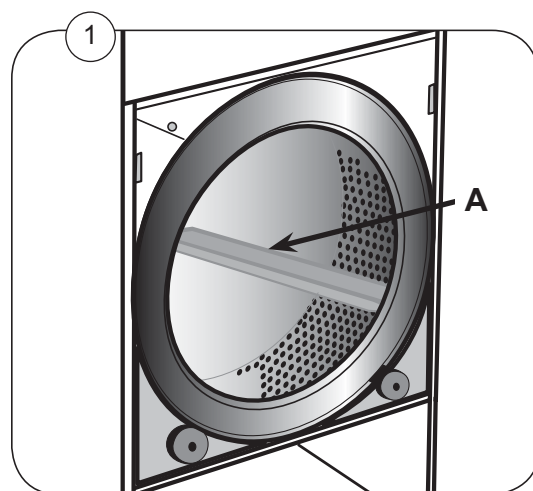



To be carried out by
qualified personnel.



Quarterly/Semi-annually

Disconnect the power to the dryer.

- Check and clean the fan wheel, fig. 1.

Annually

Disconnect the power to the dryer.

- Dismount front panel and finger protector. Clean for lint/dust, fig. 2.
- T4650: Check and tighten the support rollers.
- At least once a year, the inside wearing parts should be checked by a skilled expert and cleaned for lint.
- Check and clean the non-return flap **A**, fig. 3.

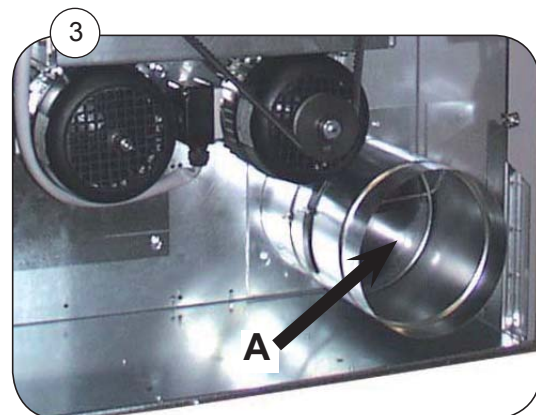
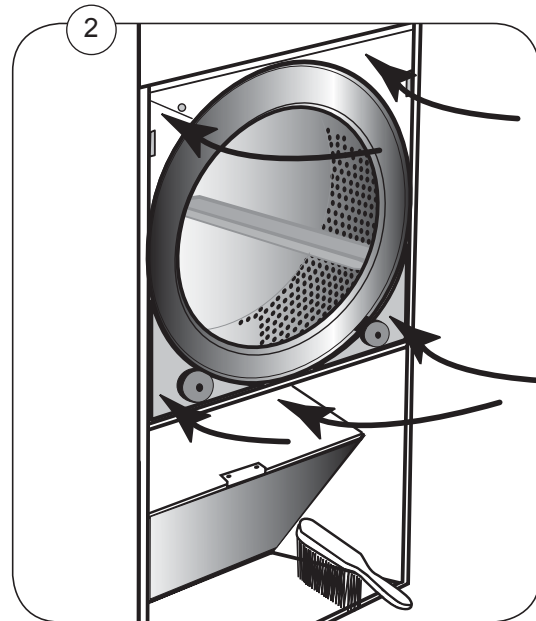
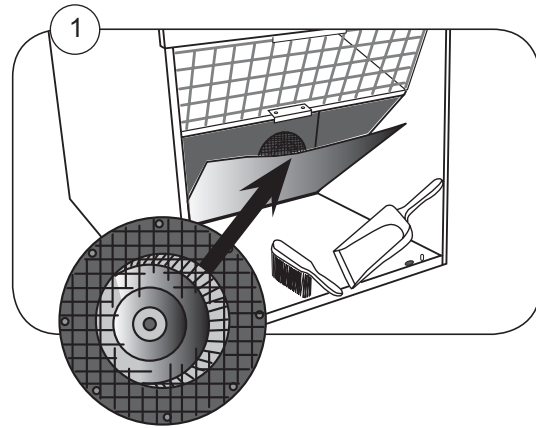



Skrotning av maskin

När maskinen inte längre skall användas måste den lämnas till en återvinningsstation för destruktion. Många detaljer i maskinen går att återanvända, men den innehåller även annat material som måste tas om hand på ett korrekt sätt. Lämna därför aldrig maskinen eller delar av maskinen i hushållsavfallet, eftersom det kan leda till hälsorisker eller skador på miljön.

Scrapping of machine

When the machine is no longer to be used, it must be submitted to a recycling facility for destruction. The majority of the components in the machine can be reused, but it also contains other material that must be taken care of in the correct way. Therefore, never mix the machine or its parts with domestic waste as this may lead to health hazards or damage to the environment.

Entsorgung des Geräts

Wenn das Gerät nicht länger im Gebrauch ist, muss dieses einer Recyclingstation zur Entsorgung zugeführt werden. Viele Komponenten des Geräts sind recyclingfähig, enthalten aber auch Materialien, die vorschriftsmäßig entsorgt werden müssen. Entsorgen Sie daher das Gerät oder Geräteteile niemals im Hausmüll, da dies Gefahren für die Gesundheit oder Umweltschäden nach sich ziehen kann.

Mise au rebut de machine

Lorsque la machine n'est plus utilisée, elle doit être déposée à une installation de recyclage pour y être détruite. La majorité des composants de la machine peuvent être réutilisés mais celle-ci contient également d'autres matériaux qui doivent être traités correctement. C'est pourquoi vous ne devez jamais mélanger la machine ou ses pièces avec les ordures ménagères, risque de pollution pour l'environnement ou la santé.

Desguace de la máquina

Cuando la máquina no tenga que utilizarse más, ha de entregarse a una instalación de destrucción para su reciclado. La mayor parte de sus componentes pueden volver a utilizarse, pero consta también de otros materiales que han de ser tratados de la manera correcta. Por esa razón nunca mezclar la máquina ni sus partes con la basura doméstica pues esto podría constituir un peligro para la salud o dañar el medio ambiente.

Bortskaffelse af maskinen

Når maskinen ikke længere er i brug, skal den afleveres til destruktion på en genbrugsstation. Mange dele i maskinen kan genanvendes, men den indeholder også andre materialer, der skal håndteres korrekt. Smid derfor ikke maskinen eller dele af den ud sammen med husholdningens almindelige affald, da det kan være forbundet med sundhedsrisiko eller give miljøskader.

Koneen hävittäminen

Kun konetta ei enää käytetä, se pitää luovuttaa kierrätyskeskukseen tuhottavaksi. Suurinta osaa koneen osista voidaan käyttää uudelleen, mutta se sisältää myös materiaaleja, jotka pitää käsitellä asianmukaisesti. Älä sen vuoksi koskaan laita konetta tai sen osia kotitalousjätteen sekaan, sillä se saattaa aiheuttaa terveysriskejä tai vahinkoa ympäristölle.

Skroting av maskin

Når maskinen ikke lenger skal brukes, må den leveres til en gjenvinningsstasjon for destruksjon. Det går an å gjenbruke mange deler av maskinen, men den inneholder også annet materiale som man må ta hånd om på riktig måte. Legg derfor aldri maskinen eller deler av maskinen i husholdningsavfallet, siden det kan føre til helse- eller miljøskader.

Afdanken van de machine

Als de machine niet langer gebruikt gaat worden, moet deze ter vernietiging worden aangeboden bij een recyclinginrichting. De meeste componenten van de machine kunnen worden hergebruikt, maar hij bevat ook ander materiaal dat op een juiste wijze moet worden behandeld. Daarom de machine of zijn onderdelen nooit bij het huisvuil zetten, want dat kan leiden tot gezondheidsrisico's of schade aan het milieu.

Rottamazione della macchina

Quando la macchina non può più essere utilizzata, deve essere affidata a un centro di riciclaggio che ne effettui la rottamazione. La maggior parte dei componenti della macchina sono riciclabili, ma ce ne sono anche alcuni che devono essere smaltiti in modo appropriato. Perciò, non mischiare mai la macchina o parti di essa con i normali rifiuti domestici, poiché ciò potrebbe comportare rischi per la salute o per l'ambiente.

Złomowanie maszyny

Wycofaną z użytkowania maszynę należy przekazać do zakładu utylizacji w celu złomowania. Większość podzespołów maszyny nadaje się do powtórnego wykorzystania, lecz zawiera ona także inne materiały, z którymi należy postępować w odpowiedni sposób. Z tego powodu niedozwolone jest łączenie maszyny lub jej części z odpadami domowymi, gdyż może to prowadzić do zagrożenia zdrowia lub szkody dla środowiska.

Vyřazení přístroje

Přístroj, který již nebude používán, by měl být odevzdán k likvidaci do ekologického zařízení. Většina součástí přístroje může být opětovně použita, některé ale vyžadují likvidaci přesně daným způsobem. A proto nikdy nemíchejte dohromady přístroje nebo jejich části s domácím odpadem, mohlo by to vést ke zdravotním rizikům nebo k poškození životního prostředí.

487 01 05 30.09

TUMBLE DRYERS HYDRO-EXTRACTORS

Types:

H1... , H1...R , N1...E. , N1...EC. , N1...G1.
N2...E. , N2...G1. , N2...S. , N3...E. , N3...G1. , N3...G3. , N3...LE.
N4...E. , N4...G2. , N4...HW. , N4...S.
N4...E. , N4...G2. , N4...S.

Product standard: EN 60335

Försäkran om överensstämmelse

Vi, Electrolux Laundry Systems Sweden AB
SE-341 80 Ljungby, Sverige

försäkrar under eget ansvar att denna produkt, med typbeteckning och enl. ovan, är tillverkad i överensstämmelse med följande direktiv:

- LVD - direktivet (73/23/EC)
- EMC - direktivet (89/336/EC)
- MD - direktivet (98/37/EC)
- Gas - direktivet (90/396/EC)
- RoHS- direktivet (2002/95/EC)

CE Declaration of conformity

We, Electrolux Laundry Systems Sweden AB
SE-341 80 Ljungby, Sweden

declare under our sole responsibility that the product of the type stated above is manufactured in conformity with the following [EU] directives:

- LVD - directive (73/23/EC)
- EMC - directive (89/336/EC)
- MD - directive (98/37/EC)
- Gas - directive (90/396/EC)
- RoHS- directive (2002/95/EC)

EG-Konformitetserklaring

Wir, die Electrolux Laundry Systems Sweden AB
SE-341 80 Ljungby, Schweden

erklären hiermit in alleiniger Verantwortung, daß das Produkt mit der oben genannten Typen-bezeichnung mit folgenden EU-Richtlinien übereinstimmt:

- LVD - Direktive (73/23/EC)
- EMC - Direktive (89/336/EC)
- MD - Direktive (98/37/EC)
- Gas - Direktive (90/396/EC)
- RoHS- Direktive (2002/95/EC)

Déclaration de conformité CE

Nous, Electrolux Laundry Systems Sweden AB
SE-341 80 Ljungby, Suède

déclarons sous notre seule et unique responsabilité que le produit des type et numéro de série indiqués ci-dessus est fabriqué conformément aux directives UE suivantes:

- LVD - Directive (73/23/CE)
- EMC - Directive (89/336/CE)
- MD - Directive (98/37/CE)
- Gaz - Directive (90/396/CE)
- RoHS- Directive (2002/95/CE)

Declaración de conformidad CE

Electrolux Laundry Systems Sweden AB
con sede en SE-341 80 Ljungby, Suecia

declara bajo su exclusiva responsabilidad que el producto cuyo tipo se especifica en el encabezado se ha fabricado conforme a las siguientes directivas:

- LVD - directiva (73/23/CE)
- EMC - directiva (89/336/CE)
- MD - directiva (98/37/CE)
- Gas - directiva (90/396/CE)
- RoHS - directiva (2002/95/CE)

Erklæring om EU-overensstemmelse

Vi, Electrolux Laundry Systems Sweden AB
SE-341 80 Ljungby, Sverige,

erklærer på eget ansvar, at produktet med typebetegnelse som angivet er fremstillet i overensstemmelse med følgende EU-direktiver:

- LVD - direktivet (73/23/EC)
- EMC - direktivet (89/336/EC)
- MD - direktivet (98/37/EC)
- Gas - direktivet (90/396/EC)
- RoHS- direktivet (2002/95/EC)

EY-Vaativuorustuksen mukaisuusvakuutus

Me, Electrolux Laundry Systems Sweden AB
SE-341 80 Ljungby, Ruotsi

vakuutamme yksinomaan omalla vastuullamme, että tuote, jonka tyyppitunnus lukee yllä, on valmistettu seuraavien [EU]-direktiivien mukaisesti:

- LVD - direktiivi (73/23/EC)
- EMC - direktiivi (89/336/EC)
- MD - direktiivi (98/37/EC)
- Kaasu - direktiivi (90/396/EC)
- RoHS- direktiivi (2002/95/EY)

EG-Conformiteitsverklaring

Wij, Electrolux Laundry Systems Sweden AB
SE-341 80 Ljungby, Zweden

verklaan hierbij op eigen verantwoordelijkheid dat het produkt van het type en met het serienummer zoals hieronder vermeld, is vervaardigd conform de volgende normen:

- LVD - direktive (73/23/EC)
- EMC - direktive (89/336/EC)
- MD - direktive (98/37/EC)
- Gas - direktive (90/396/EC)
- RoHS- direktive (2002/95/EC)

Dichiarazione CE di conformità

Noi, Electrolux Laundry Systems Sweden AB
SE-341 80 Ljungby, Svezia

dichiariamo sotto la nostra esclusiva responsabilità che il prodotto del tipo specificato sopra è conforme alle seguenti direttive [UE]:

- LVD - direttiva (73/23/CE)
- EMC - direttiva (89/336/CE)
- MD - direttiva (98/37/CE)
- Gas - direttiva (90/396/CE)
- RoHS - direttiva (2002/95/CE)

Declaração CE de conformidade

Nós, Electrolux Laundry Systems Sweden AB
SE-341 80 Ljungby, Suécia

declaramos sob nossa inteira responsabilidade que o produto com os números de série e de tipo abaixo indicados é fabricado em conformidade com as seguintes directivas [UE]:

- LVD - directiva (73/23/CE)
- EMC - directiva (89/336/CE)
- MD - directiva (98/37/CE)
- Gás - directiva (90/396/CE)
- RoHS - directiva (2002/95/CE)

Δήλωση συμμόρφωσης CE

Εμείς, η εταιρεία Electrolux Laundry Systems Sweden AB
SE-341 80 Ljungby, Σουηδία

δηλώνουμε με αποκλειστική μας ευθύνη ότι ο τύπος του προϊόντος που αναφέρεται παραπάνω κατασκευάζεται σύμφωνα με τις ακόλουθες οδηγίες της [EE]:

- Οδηγία περί Χαμηλής Τάσης (73/23/EE)
- Οδηγία περί Ηλεκτρομαγνητικής Συμβατότητας (89/336/EE)
- Οδηγία περί Μηχανημάτων (98/37/EE)
- Οδηγία περί Συσκευών Αερίου (90/396/EE)
- Οδηγία περί Ηλεκτρικού και Ηλεκτρονικού Εξοπλισμού (2002/95/EE)

CE megfelelési nyilatkozat

Mi, az Electrolux Laundry Systems Sweden AB
SE-341 80 Ljungby, Svédország

felelősségünk teljes tudatában kijelentjük, hogy az alább megadott típusú termék gyártása a következő EU-irányelvekkel összhangban történik:

- a 73/23/EGK irányelv
- a 89/336/EGK irányelv
- a 98/37/EGK irányelv
- a 90/396/EGK irányelv
- RoHS direktívi (2002/95/EC)

EF-samsvarserklæring

Vi, Electrolux Laundry Systems Sweden AB
SE-341 80 Ljungby, Sverige

erklærer på eget ansvar at dette produktet, med typebetegnelse og produktionsnummer som angitt nedenfor, er produsert i samsvar med bestemmelsene i følgende direktiver:

- LVD - direktivet (73/23/EC)
- EMC - direktivet (89/336/EC)
- MD - direktivet (98/37/EC)
- Gas - direktivet (90/396/EC)
- RoHS - direktivet (2002/95/EC)

Ljungby 2006.05.23

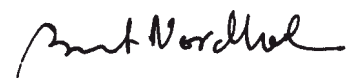

Bert Nordholm
Production Director



www.electrolux.com/professional

Share more of our thinking at www.electrolux.com