

# **Operating Manual**

## **W455H**



# Contents

---

## Contents

Safety precautions .....	5
General.....	7
Control panel.....	7
Control knob.....	7
Display.....	8
Preset buttons .....	8
Wash program.....	9
Start menu.....	10
Start.....	10
Options.....	10
Program time.....	13
Delayed start .....	13
Info .....	13
Exit .....	13
Washing functions.....	14
Start.....	14
Rapid advance .....	14
Pause .....	14
Changing or discontinue a wash program after starting.....	14
Detergent supply .....	15
Remaining time .....	16
Handling.....	17
Starting with control knob.....	17
Starting with preset button .....	18
Error messages .....	19
Maintenance.....	21
Daily.....	21
Every month .....	21
Every third month .....	21



# Safety Precautions

---



## Safety Precautions



- The machine is only intended for water-wash use.
- Do not allow minors to use the machine.
- Do not hose down the machine with water.
- The machine's door lock must under no circumstances be bypassed.
- Report any faults that arise to the relevant technician as soon as possible. This is important both for your safety and that of others.
- The product is not intended to be used by people (including minors) with reduced physical or mental capacity or lack of experience and knowledge. Such people must be instructed in the use of the product by a person who has responsibility for their safety. Minors must be supervised to ensure that they do not play with the product.



**All external equipment which is connected to the machine must be CE/EMC-approved and connected using an approved shielded cable.**

The manufacturer reserves the right to make changes to design and component specifications.



## General

### Control panel

- 1 The control panel is used to choose the wash program with options and to start and stop the machine. The panel houses a control knob and a display. Some machines also have two preset buttons.

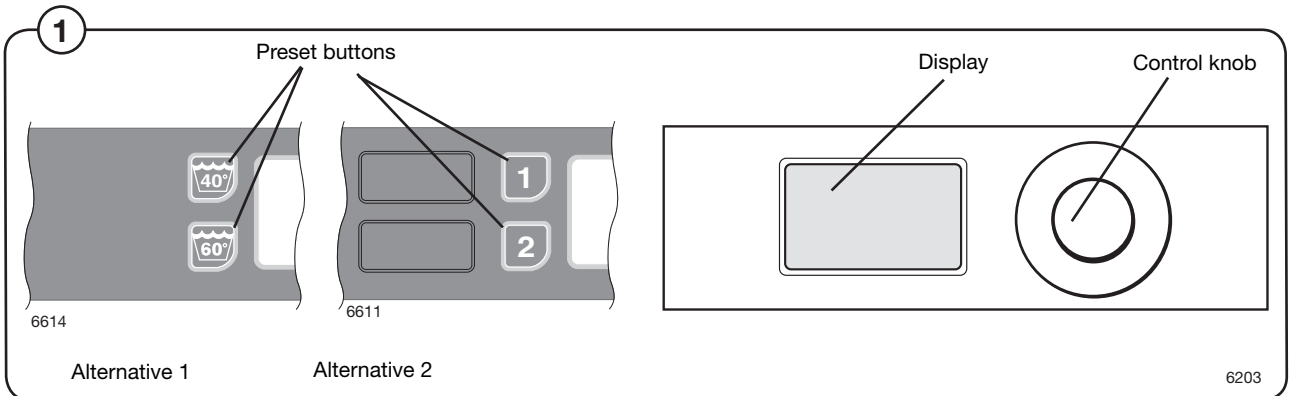

### Control knob

The control knob is used to select wash program, options and any other available functions.

- 2 Turn the knob until the required option is shown on the display.
- 3 Confirm your choice by pushing in the knob. Repeat this procedure until all the required options have been chosen.

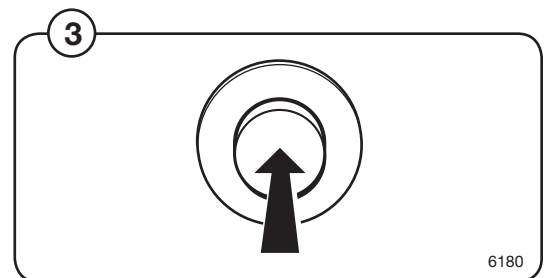
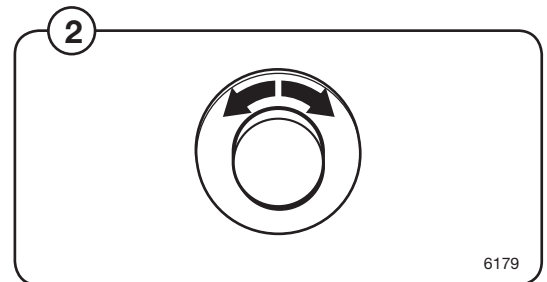

## Display

- ④ The display presents the wash programs, options and additional functions. The up and down arrows on the right-hand side of the display indicate that there are more options available in the current menu. Turn the knob for next program.

While in operation, the display also shows other information intended for the user.

### Note!

**If there is not enough room to show all the text on the display, the first part will be displayed briefly before the text scrolls to the side to display the second part. This sequence will be repeated as long the text in question is activated.**

## Preset buttons

- ⑤ The machine can be fitted with two buttons for choosing two preset wash programs.

Pushing one of these buttons will activate the corresponding wash program directly and the machine will start automatically if the dorr has been closed before the button is activated.

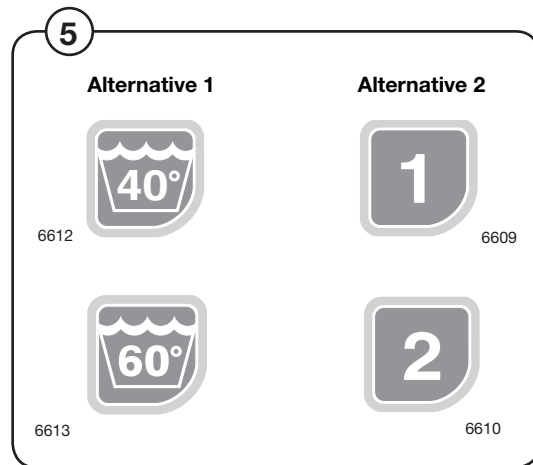
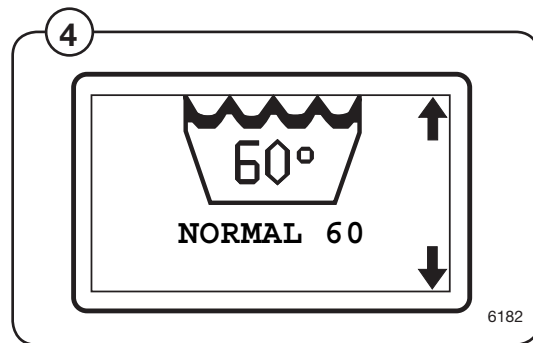



## Wash program

The machine is programmed with a number of programs adapted to the range of uses to which the machine is intended.

The following wash programs can be available:

- ① Wash program Normal. Cotton. Full load. Different temperatures can be selected.
- ② Wash program Synthetics. Mixed textiles. Half load. Different temperatures can be selected.
- ③ Wash program Delicate, 30°C. Half load.
- ④ Wash program Wool, 40°C. Half load.
- ⑤ Wash program Handwash, 30°C.
- ⑥ Extraction program. The machine extracts three minutes. E.g textiles which have been washed by hand.

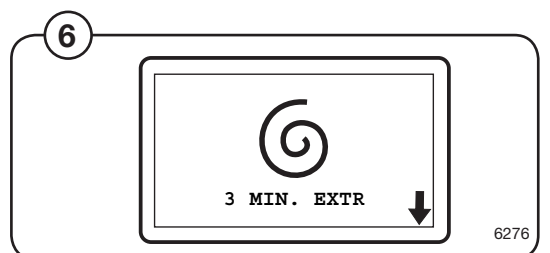
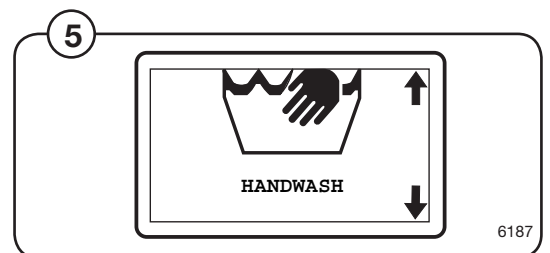
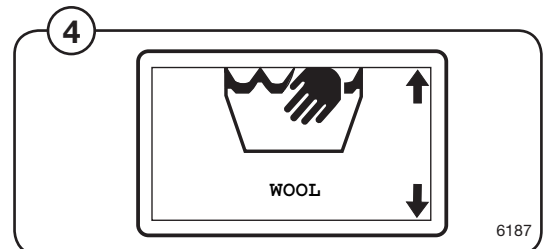
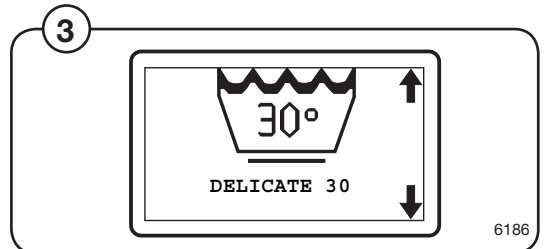
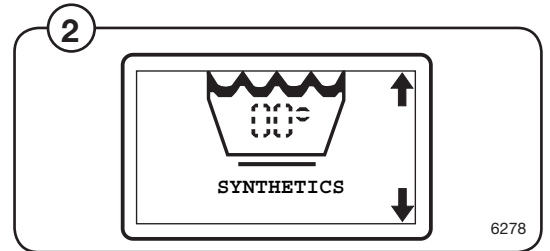
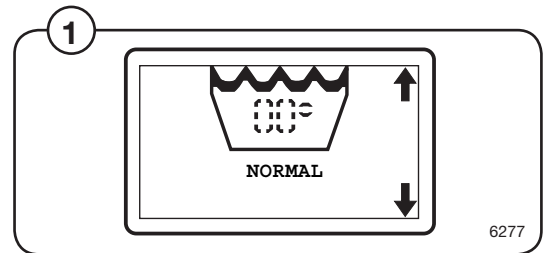

## Start menu

- ① A start menu will appear on the display once a wash program has been selected. Here, you can complement the selected wash program with up to two options (on certain machines), select how the machine is to start and obtain information on the selected wash program. Refer to the respective headings for more information.

If the selected option may not be used, the text "Function not allowed" will be shown in the display.

### Start

The wash program starts immediately after pressing the control knob.

### Options

- ② Before starting, the selected wash program can be complemented with up to two options. The activated option is indicated on the display under the name of the wash program as "Option 1", "Option 2", etc.

The following options can be available:

#### "PRERINSES"

- ③ The selected wash program is complemented with two prerinses of 2 minutes each.

#### "PREWASH"

- ④ The selected wash program is complemented with a prewash.

#### "HEAVY SOILED"

- ⑤ The selected wash program is complemented with a prewash, the time for the main wash is extended and at temperatures above 41°C, the temperature is increased by 8 °C.

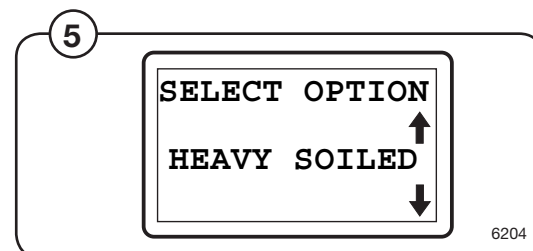
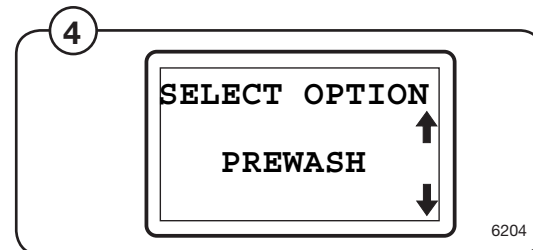
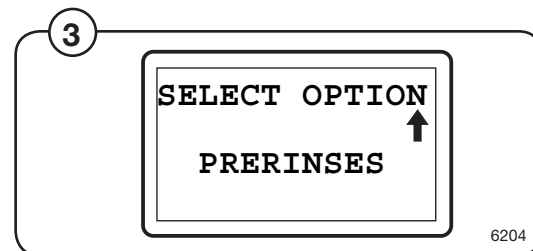
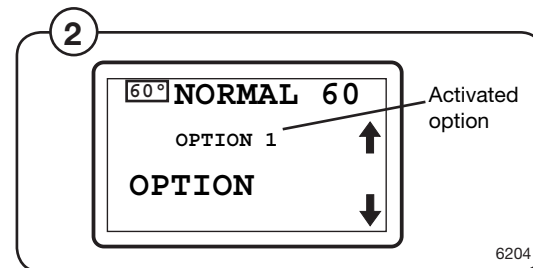
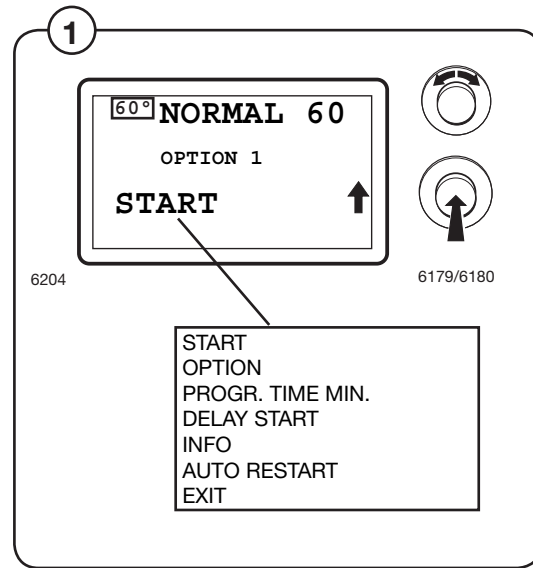

**"NO PREWASH"**

- ⑥ Prewash will be excluded from the selected wash program.

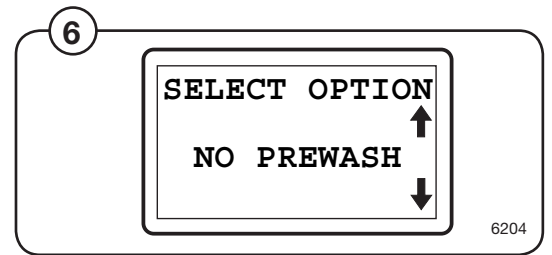

**"LIGHT SOILED"**

- ⑦ The temperature is lowered 5 °C at all temperatures and the main wash shortened by 4 minutes.

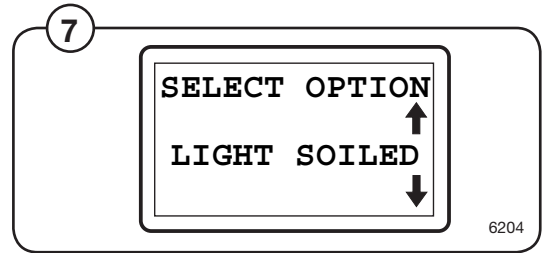

**"QUICK WASH"**

- ⑧ The machine excludes the selected wash program's prewash and shortens spin drying by 2 minutes.

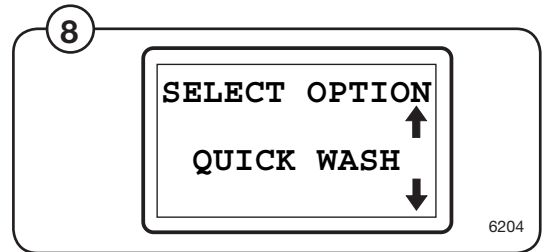

**"HIGHER LEVEL"**

- ⑨ All the levels for the selected wash program are increased by 5 units.

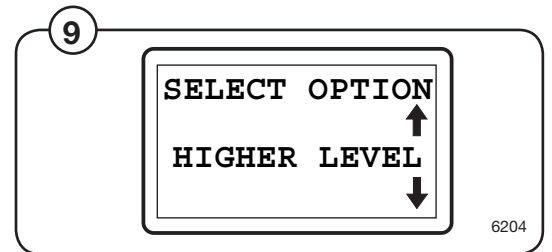

**"RINSE STOP"**

- ⑩ The selected wash program stops before the final rinse. To fill with water and continue with the wash program, the control knob must be pressed in.



**"EXTRA RINSE"**

- ⑪ Gives an extra rinse in the selected wash program.

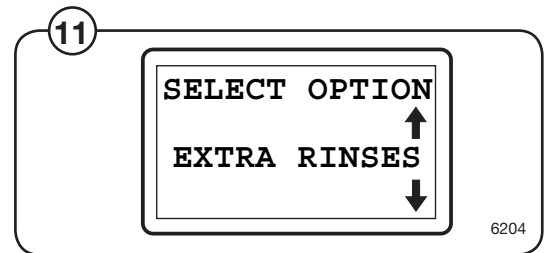

**"GENTLE EXTRACTION"**

- ⑫ Extraction in the selected wash program is excluded between rinses and the final extraction is shorter.

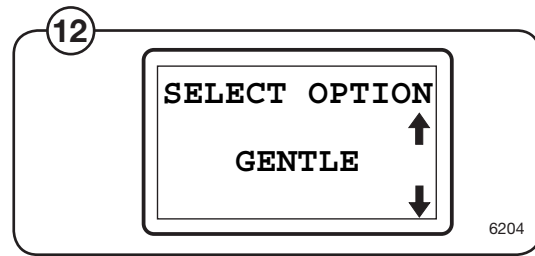
**"SHORT EXTRACTION"**

- ⑬ Final spin dry in selected wash program is shortened by 4 minutes.

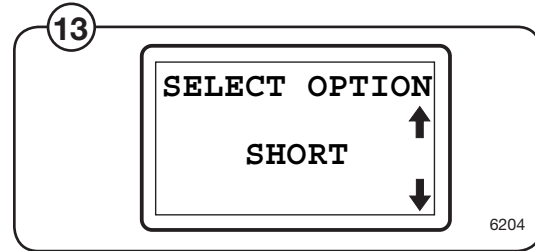
**"EXTRA EXTRACTION"**

- ⑭ Final spin dry in selected wash program is extended by 2 minutes.

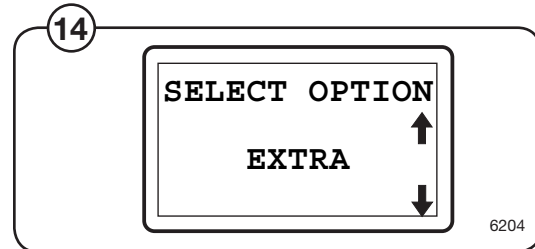
**"EXTRACTION (TIME)."**

- ⑮ The duration of the final extraction in the selected wash program can be selected.

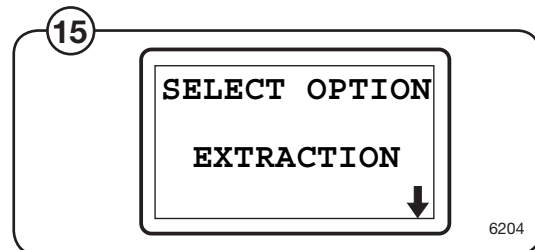

**Program time**

- ①⑥ Shows approximate wash time for selected program.

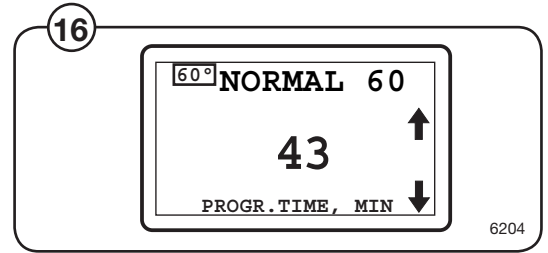

**Delayed start**

In this menu, you can set a delay of up to 99 hours and 59 minutes before the machine starts the selected wash program.

- ①⑦ The arrow in the menu indicates the column being adjusted. Turn the knob clockwise to set the desired number. Turn the knob anticlockwise to move to the next column. Press the knob to confirm after completing the settings.

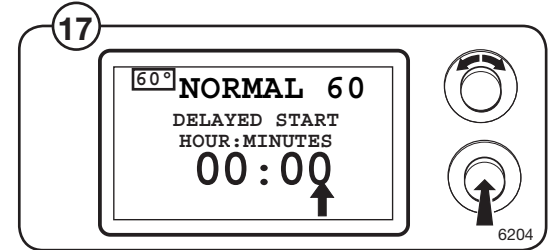

The time left to start starts when the setting has been confirmed.

- ①⑧ It will be indicated on the display if the selected wash program does not allow this function.

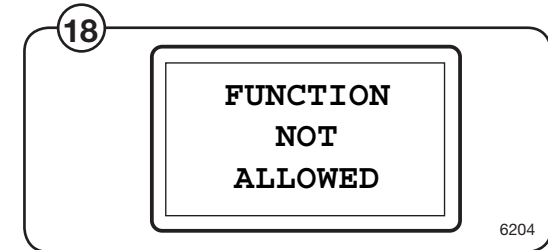

**Info**

- ①⑨ This menu presents information on the selected wash program.

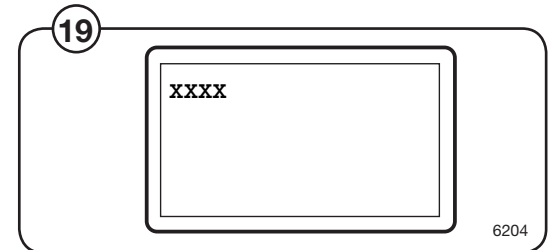

**Exit**

Return to the program selection menu.

## Washing functions

### START

- ① Turn the control knob to the START row. Press the knob to start the selected program.
- ② On machines equipped with preset buttons, the preset wash program can be started with the respective button.

### RAPID ADVANCE

- ③ Turn the control knob while the wash program is in progress.
- ④ The different steps of the wash program will be shown on the display. Turn the knob to the desired program step and press. The machine will now jump to the selected step and continue the program from there.

### PAUSE

- ⑤ Press the control knob to turn on the pause function. Restart the wash program by pressing the control knob again.

**Note!**

**The door will be locked and the drain valve closed during the pause.**



### Changing or discontinue a wash program after starting

- ⑥ Press the control knob to start the pause function. Turn the control knob for a new menu and select function.

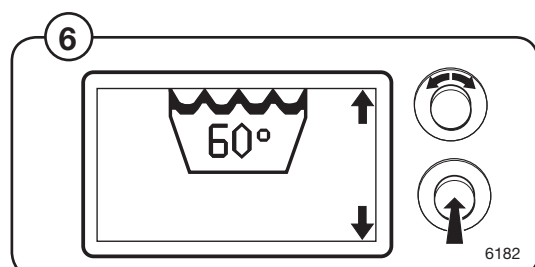
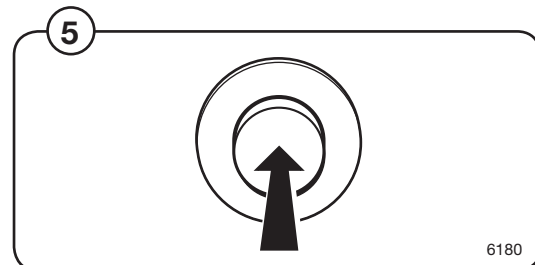
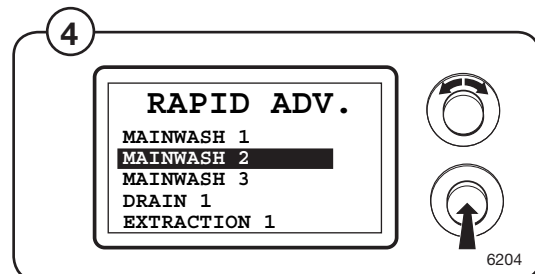
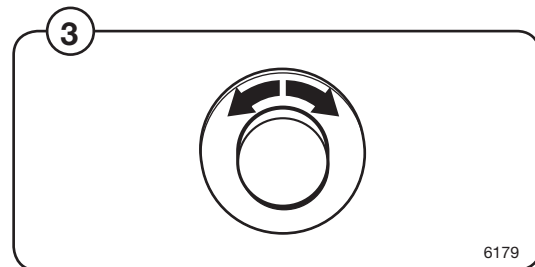
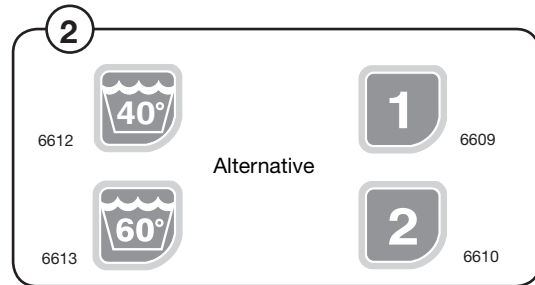
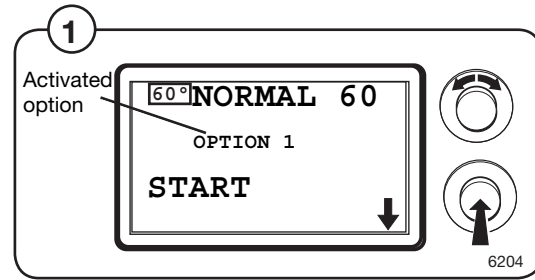
If no program is selected the machine will return to pause after 10 seconds.



**Detergent supply**

- 7

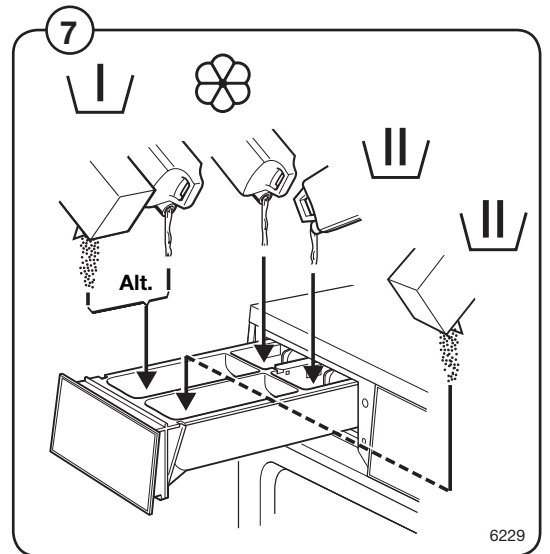
 Prewash, powder or liquid detergent, if option "Prewash" has been selected.
  
- 
 Main wash. Two compartments, one for powder detergent and one for liquid.
  
- 
 Fabric softener, liquid



### Remaining time

- 8 During the wash, the remaining time for the selected wash program will be shown at the bottom of the display. The time is given in minutes.

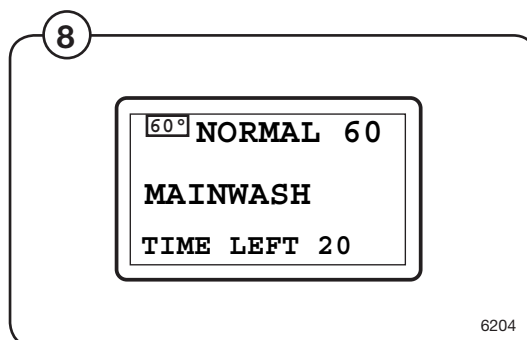
To calculate the remaining time, the machine uses a model calculation based on earlier used wash programs.





## Starting with control knob

- ① • Select the desired wash program with the control knob and confirm by pressing the knob.
- ② • Add any options to the selected wash program. Select from the list with the control knob and confirm by pressing the knob.

**Note!**

**Max two options can be chosen for each wash program**

- If the machine has a coin meter, insert the correct amount of coins/tokens.
- ③ • Add the correct amount of detergent and softener.

**Note!**

**Refer to the dosages on the detergent packaging. Do not overdose.**

- ④ • Select START with the control knob and press the knob.

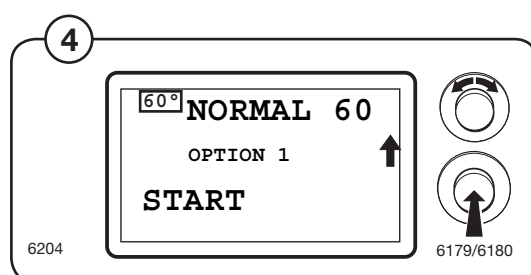
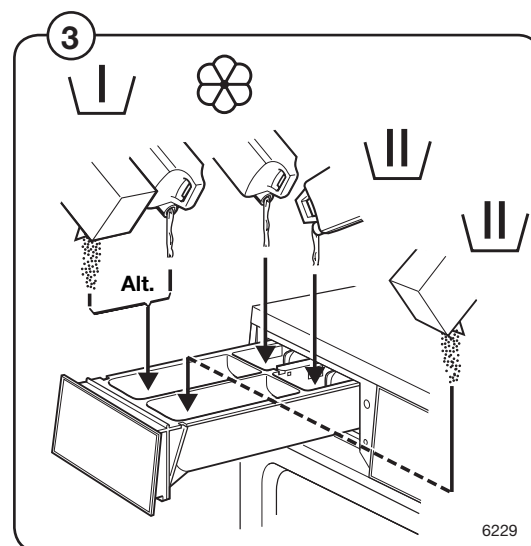
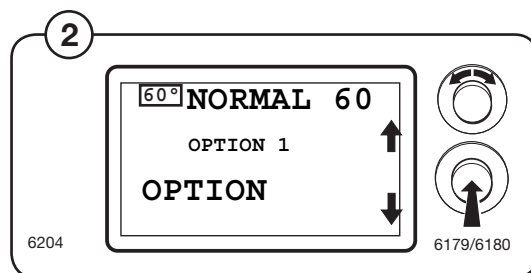
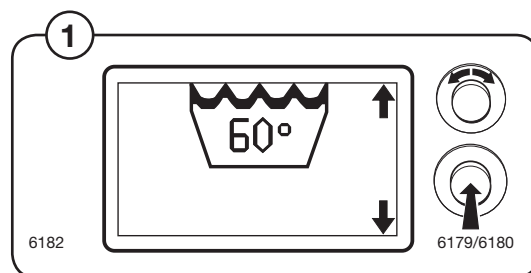

## Starting with preset button

- Empty any pockets.
- Close the door.
- ① • Add the correct amount of detergent and softener.

**Note!**

**Refer to the dosages on the detergent packaging. Do not overdose.**

- ② • Press the preset button for the desired program.
- If the machine has a coin meter, insert the correct amount of coins/tokens.

**Note!**

**Pushing one of these buttons will activate the corresponding wash program directly and the machine will start automatically.**

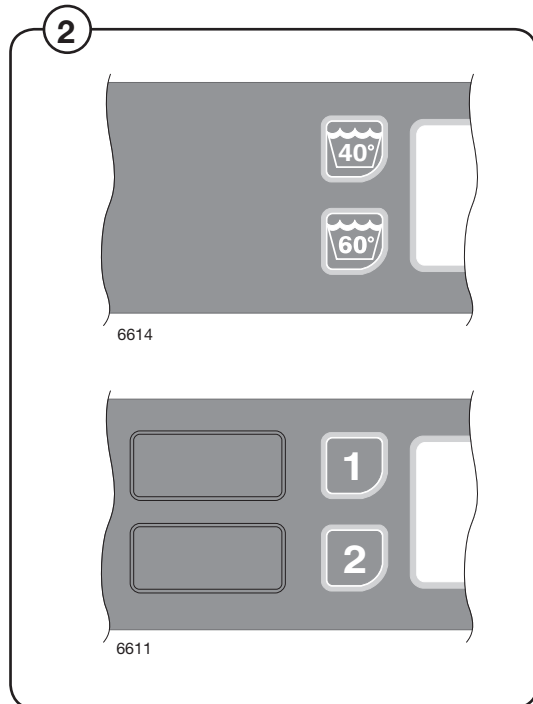
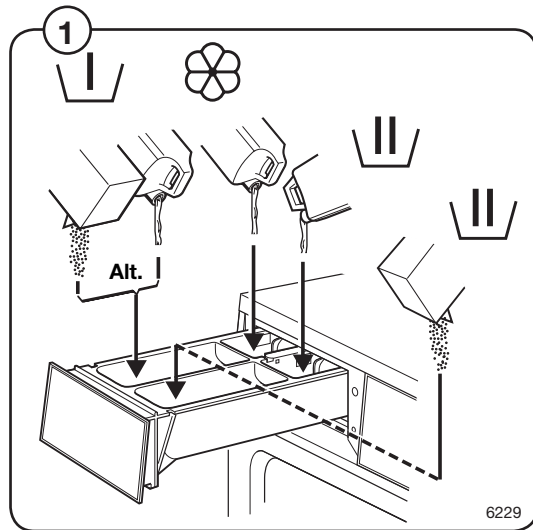

## Error messages

- ① A fault in the program or in the machine is indicated by an error message comprising an error code and a descriptive text.

Resetting of error code and restart of washing program can be done by a quick press on the knob. If the error code returns after resetting, a total reset has to be done, by pressing the knob at least 10 seconds. The wash program is then finished and the door can be opened, provided that there is no water left in the drum.

**Note!**

**Some error codes keep the door locked for 5 minutes after resetting. During this time, do not try to start a wash program.**

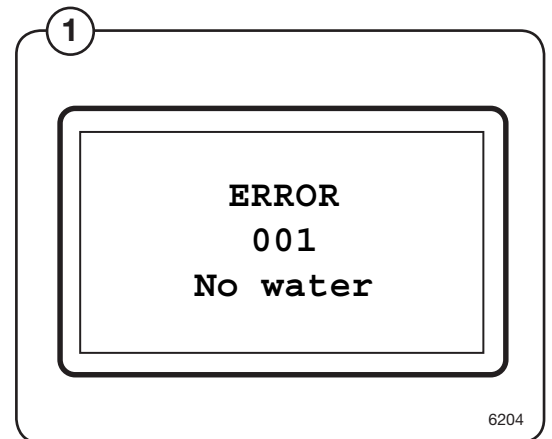

CodeText	Cause/Action
001 NO WATER	Water level acknowledgement not received in time. Make sure the water cocks are open.
002 DOOR OPEN	Door position acknowledgement not received during program. Open and close the door.
003 DOOR LOCK FAIL	Door lock acknowledgement not received in time. Open and close the door.
007 OVERFILLED	Water level above established safety limits during program. Try to restart the machine.
010 DRUM NOT DRAINED	Water above established level after drain. Make sure the drain is not blocked by lint or foam. Try to restart the machine.

For other error messages or repeated error messages, contact service personnel.



## Maintenance

### Daily

- Clean the door seal from detergent residue.
- Make sure the door is not leaking.
- Clean the detergent supply box and wipe off the machine with a damp rag.
- Make sure the drain valve is not leaking.
- Start the machine and make sure the door is locked during the program. Rapid advance the program to stop and make sure the door cannot be opened until after the program is complete.

### Every month

- Check that valves, hoses and connections are not leaking.
- Remove any lint from the drain connection, joints in the drain pipe, etc.

### Every third month

When chemicals have collected on the edges of the panels:

- Turn off power to machine.
- Turn off the water supply and release the pressure from the inlet hoses.
- Remove the water inlet hoses from the back of the machine and clean or change the inlet filter.
- Clean the detergent supply box thoroughly.
- Take off the top and front machine panels.
- Wash away detergent and other chemicals from the panels to stop them rusting.
- Make sure there are no leaks inside the machine. Repair as necessary.
- Clean the seal around the door.
- Refit the top and front panels.
- Deliming. Use a program with high temperature and add a deliming agent, e.g. citric acid.



**Types: W.55H., W3..., W4.H., EXSM.X.****Product standard: EN 60335-2-7**

## Washer Extractors

### Försäkran om överensstämmelse

Vi, Electrolux Laundry Systems Sweden AB  
SE-341 80 Ljungby, Sverige

försäkrar under eget ansvar att denna produkt, med typbeteckning och enl. ovan, är tillverkad i överensstämmelse med följande direktiv:

- Maskindirektivet 98/37/EEC
- Lågspänningsdirektivet 73/23/EEC
- EMC-direktivet 89/336/EEC
- RoHS-direktivet 2002/95/EC

### CE Declaration of conformity

We, Electrolux Laundry Systems Sweden AB  
SE-341 80 Ljungby, Sweden

declare under our sole responsibility that the product of the type stated above is manufactured in conformity with the following [EU] directives:

- Directive 98/37/EEC
- Directive 73/23/EEC
- Directive 89/336/EEC
- RoHS-directive 2002/95/EC

### EG-Konformitätserklärung

Wir, die, Electrolux Laundry Systems Sweden AB  
SE-341 80 Ljungby, Schweden

erklären hiermit in alleiniger Verantwortung, daß das Produkt mit der oben genannten Typenbezeichnung mit folgenden EU-Richtlinien übereinstimmt:

- Richtlinie 98/37/EWG
- Richtlinie 73/23/EWG
- Richtlinie 89/336/EWG
- Richtlinie 2002/95/EC

### Déclaration de conformité CE

Nous, Electrolux Laundry Systems Sweden AB  
SE-341 80 Ljungby, Suède

déclarons sous notre seule et unique responsabilité que le produit des type et numéro de série indiqués ci-dessus est fabriqué conformément aux directives UE suivantes:

- Directive 98/37/CEE
- Directive 73/23/CEE
- Directive 89/336/CEE
- RoHS-directif 2002/95/EC

### Declaración de conformidad CE

Electrolux Laundry Systems Sweden AB  
con sede en SE-341 80 Ljungby, Suecia

declara bajo su exclusiva responsabilidad que el producto cuyo tipo se especifica en el encabezado se ha fabricado conforme a las siguientes directivas:

- Directiva 98/37/CEE sobre maquinaria
- Directiva 73/23/CEE sobre maquinaria
- Directiva 89/336/CEE sobre maquinaria
- RoHS-directiva 2002/95/EC

### Erklæring om EU-overensstemmelse

Vi, Electrolux Laundry Systems Sweden AB  
SE-341 80 Ljungby, Sverige

erklærer på eget ansvar, at produktet med typebetegnelse som angivet er fremstillet i overensstemmelse med følgende EU-direktiver:

- 98/37/EØF (maskindirektivet)
- 73/23/EØF (lavspændingsdirektivet)
- 89/336/EØF (EMC-direktivet)
- RoHS-direktiv 2002/95/EC

### EY-Vaatimustenmukaisuusvakuutus

Me, Electrolux Laundry Systems Sweden AB  
SE-341 80 Ljungby, Ruotsi

vakuutamme yksinomaan omalla vastuullamme, että tuote, jonka tyyppitunnus lukee yllä, on valmistettu seuraavien [EU]-direktiivien mukaisesti:

- Konedirektiivi 98/37/ETY
- Pienjännitedirektiivi 73/23/ETY
- EMC-direktiivi 89/336/ETY
- RoHS-direktiivi 2002/95/EC

### EF-samsvarserklæring

Vi, Electrolux Laundry Systems Sweden AB  
SE-341 80 Ljungby, Sverige,

erklærer på eget ansvar at dette produktet, med typebetegnelse og produktionsnummer som angitt nedenfor, er produsert i samsvar med bestemmelsene i følgende direktiver:

- Maskindirektivet 98/37/EØF
- Lavspenningsdirektivet 73/23/EØF
- EMC-direktivet 89/336/EØF
- RoHS-direktivet 2002/95/EC

### EG-Conformiteitsverklaring

Wij, Electrolux Laundry Systems Sweden AB  
SE-341 80 Ljungby, Zweden

verklaren hierbij op eigen verantwoordelijkheid dat het product van het type en met het serienummer zoals hieronder vermeld, is vervaardigd conform de volgende normen:

- Machinenorm 98/37/EEG
- Laagspanningsnorm 73/23/EEG
- EMC-norm 89/336/EEG
- RoHS-richtlijn 2002/95/EC

### Dichiarazione CE di conformità

Noi, Electrolux Laundry Systems Sweden AB  
SE-341 80 Ljungby, Svezia

dichiariamo sotto la nostra esclusiva responsabilità che il prodotto del tipo specificato sopra è conforme alle seguenti direttive [UE]:

- Direttiva sulle macchine 98/37/CEE
- Direttiva sulla bassa tensione 73/23/CEE
- Direttiva sulla CEM 89/366/CEE
- Direttiva RoHS 2002/95/EC

### Declaração CE de conformidade

Nós, Electrolux Laundry Systems Sweden AB  
SE-341 80 Ljungby, Suécia

declaramos sob nossa inteira responsabilidade que o produto com os números de série e de tipo abaixo indicados é fabricado em conformidade com as seguintes directivas [UE]:

- Directiva 98/37/CEE sobre maquinaria
- Directiva 73/23/CEE sobre baixa tensão
- Directiva 89/336/CEE sobre compatibilidade electromagnética
- RoHS-directiva 2002/95/EC

### ΔΗΛΩΣΗ ΠΙΣΤΟΤΗΤΑΣ ΕΚ

Η, Electrolux Laundry Systems Sweden AB  
SE-341 80 Ljungby, ζουηδία

δηλώνει με αποκλειστική της ευθύνη ότι το προϊόν του κάτωθι αναφερόμενου τύπου κατασκευάζεται σύμφωνα με τις παρακάτω οδηγίες της Ευρωπαϊκής Ένωσης:

- Οδηγία 98/37/EOK
- Οδηγία 73/23/EOK
- Οδηγία 89/336/EOK
- Οδηγία RoHS 2002/95/EC

### CE megfeleléségi nyilatkozat

Mi, az, Electrolux Laundry Systems Sweden AB  
SE-341 8 Ljungby, Svédország

felelősségünk teljes tudatában kijelentjük, hogy az alább megadott típusú termék gyártása a következő EU-irányelvekkel összhangban történik:

- a 98/37/EGK irányelv;
- a 73/23/EGK irányelv;
- a 89/336/EGK irányelv.
- RoHS-irányelv 2002/95/EC

Ljungby 2006.05.22

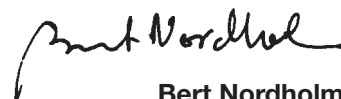

**Bert Nordholm**  
Production Director







#### Skrotning av maskin

När maskinen inte längre skall användas måste den lämnas till en återvinningsstation för destruktion. Många detaljer i maskinen går att återanvända, men den innehåller även annat material som måste tas om hand på ett korrekt sätt. Lämna därför aldrig maskinen eller delar av maskinen i hushållsavfallet, eftersom det kan leda till hälsorisker eller skador på miljön.

#### Scrapping of machine

When the machine is no longer to be used, it must be submitted to a recycling facility for destruction. The majority of the components in the machine can be reused, but it also contains other material that must be taken care of in the correct way. Therefore, never mix the machine or its parts with domestic waste as this may lead to health hazards or damage to the environment.

#### Entsorgung des Geräts

Wenn das Gerät nicht länger im Gebrauch ist, muss dieses einer Recyclingstation zur Entsorgung zugeführt werden. Viele Komponenten des Geräts sind recyclingfähig, enthalten aber auch Materialien, die vorschriftsmäßig entsorgt werden müssen. Entsorgen Sie daher das Gerät oder Geräteteile niemals im Hausmüll, da dies Gefahren für die Gesundheit oder Umweltschäden nach sich ziehen kann.

#### Mise au rebut de machine

Lorsque la machine n'est plus utilisée, elle doit être déposée à une installation de recyclage pour y être détruite. La majorité des composants de la machine peuvent être réutilisés mais celle-ci contient également d'autres matériaux qui doivent être traités correctement. C'est pourquoi vous ne devez jamais mélanger la machine ou ses pièces avec les ordures ménagères, risque de pollution pour l'environnement ou la santé.

#### Desguace de la máquina

Cuando la máquina no tenga que utilizarse más, ha de entregarse a una instalación de destrucción para su reciclado. La mayor parte de sus componentes pueden volver a utilizarse, pero consta también de otros materiales que han de ser tratados de la manera correcta. Por esa razón nunca mezclar la máquina ni sus partes con la basura doméstica pues esto podría constituir un peligro para la salud o dañar el medio ambiente.

#### Bortskaffelse af maskinen

Når maskinen ikke længere er i brug, skal den afleveres til destruktion på en genbrugsstation. Mange dele i maskinen kan genanvendes, men den indeholder også andre materialer, der skal håndteres korrekt. Smid derfor ikke maskinen eller dele af den ud sammen med husholdningens almindelige affald, da det kan være forbundet med sundhedsrisiko eller give miljøskader.

#### Koneen hävittäminen

Kun koneita ei enää käytetä, se pitää luovuttaa kierrätyskeskukseen tuhottavaksi. Suurinta osaa koneen osista voidaan käyttää uudelleen, mutta se sisältää myös materiaaleja, jotka pitää käsitellä asianmukaisesti. Älä sen vuoksi koskaan laita koneita tai sen osia kotitalousjätteen sekaan, sillä se saattaa aiheuttaa terveysriskejä tai vahinkoa ympäristölle.

#### Skrotning av maskin

Når maskinen ikke lenger skal brukes, må den leveres til en gjenvinningsstasjon for destruksjon. Det går an å gjenbruke mange deler av maskinen, men den inneholder også annet materiale som man må ta hånd om på riktig måte. Legg derfor aldri maskinen eller deler av maskinen i husholdningsavfallet, siden det kan føre til helse- eller miljøskader.

#### Afdanken van de machine

Als de machine niet langer gebruikt gaat worden, moet deze ter vernietiging worden aangeboden bij een recyclinginrichting. De meeste componenten van de machine kunnen worden hergebruikt, maar hij bevat ook ander materiaal dat op een juiste wijze moet worden behandeld. Daarom de machine of zijn onderdelen nooit bij het huisvuil zetten, want dat kan leiden tot gezondheidsrisico's of schade aan het milieu.

#### Rottamazione della macchina

Quando la macchina non può più essere utilizzata, deve essere affidata a un centro di riciclaggio che ne effettui la rottamazione. La maggior parte dei componenti della macchina sono riciclabili, ma ce ne sono anche alcuni che devono essere smaltiti in modo appropriato. Perciò, non mischiare mai la macchina o parti di essa con i normali rifiuti domestici, poiché ciò potrebbe comportare rischi per la salute o per l'ambiente.

#### Złomowanie maszyny

Wycofaną z użytkowania maszynę należy przekazać do zakładu utylizacji w celu złomowania. Większość podzespołów maszyny nadaje się do powtórnego wykorzystania, lecz zawiera ona także inne materiały, z którymi należy postępować w odpowiedni sposób. Z tego powodu niedozwolone jest łączenie maszyny lub jej części z odpadami domowymi, gdyż może to prowadzić do zagrożenia zdrowia lub szkody dla środowiska.

#### Vyřazení přístroje

Přístroj, který již nebude používán, by měl být odevzdán k likvidaci do ekodvora. Většina součástí přístroje může být opětovně použita, některé ale vyžadují likvidaci přesně daným způsobem. A proto nikdy nemíchejte dohromady přístroje nebo jejich části s domácím odpadem, mohlo by to vést ke zdravotním rizikům nebo k poškození životního prostředí.

#### Οριστική απόσυρση μηχανήματος

Όταν το μηχάνημα δεν προορίζεται για περαιτέρω χρήση, θα πρέπει να οδηγείται σε εγκατάσταση ανακύκλωσης για καταστροφή. Το μεγαλύτερο ποσοστό των εξαρτημάτων του μηχανήματος μπορεί να χρησιμοποιηθεί ξανά, αλλά το μηχάνημα περιλαμβάνει και άλλα υλικά η διαλογή των οποίων θα πρέπει να πραγματοποιείται με τον κατάλληλο τρόπο. Κατά συνέπεια, μην αναμειγνύετε ποτέ το μηχάνημα ή τα εξαρτήματά του με οικιακά απορρίμματα καθώς αυτό μπορεί να αποβεί επικίνδυνο για την υγεία ή επιβλαβές για το περιβάλλον.







[www.electrolux.com/professional](http://www.electrolux.com/professional)

Share more of our thinking at [www.electrolux.com](http://www.electrolux.com)