

Operating manual

Washer extractor

**W575S, W585S, W5105S, W5130S, W5180S,
W5250S, W5330S**

Type W3...

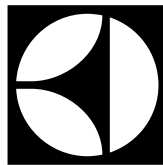

Thinking of you
Electrolux



Contents

Contents



1 Safety Precautions	5
1.1 Symbols.....	5
2 Program description	6
2.1 General.....	6
2.2 Program description	6
2.3 Option buttons	8
3 Handling	9
3.1 Load.....	9
3.2 Detergent.....	9
3.3 How to start the machine.....	10
3.3.1 AHL.....	10
3.3.2 Mop.....	11
3.3.3 Hygiene.....	12
3.3.4 Restaurant	13
3.3.5 Camping	15
3.3.6 Coin operated machines.....	16
3.4 Additional functions	17
3.5 When program has ended.....	18
4 Timer	19
5 Error codes.....	21
6 Maintenance.....	22
6.1 General.....	22
6.2 Time for maintenance.....	22
6.3 Every day.....	22
6.4 Detergent container	23
6.4.1 Deliming.....	23
6.5 Drain	23
6.6 Water inlet	24
6.7 Cleaning the mop elements.....	25
6.8 Maintenance to be carried out by qualified service personnel.....	25

The manufacturer reserves the right to make changes to design and component specifications.

1 Safety Precautions

	
<p>The machine is only intended for water-wash use.</p> <p>Only use detergent intended for water-wash of textiles. Never use dry cleaning agents.</p> <p>Do not allow minors to use the machine.</p> <p>Do not hose down the machine with water.</p> <p>The machine's door lock must under no circumstances be bypassed.</p> <p>If the machine develops a fault, this must be reported to the person in charge as soon as possible. This is important both for your safety and that of others.</p> <p>This appliance can be used by children aged from 8 years and above and persons with reduced physical, sensory or mental capabilities or lack of experience and knowledge if they have been given supervision or instruction concerning use of the appliance in a safe way and understand the hazards involved. Children shall not play with the appliance. Cleaning and user maintenance shall not be made by children without supervision.</p> <p>DO NOT MODIFY THIS APPLIANCE.</p> <p>All external equipment which is connected to the machine must be CE/EMC-approved and connected using an approved shielded cable.</p> <p>All external equipment must be connected according to the instructions in the installation manual.</p> <p>In order to prevent damage to the electronics (and other parts) that may occur as the result of condensation, the machine should be placed in room temperature for 24 hours before being used for the first time.</p> <p>Servicing shall be carried out only by authorized personnel.</p> <p>Only authorized spare parts shall be used.</p> <p>When performing service or replacing parts, the power must be disconnected.</p>	

1.1 Symbols

	Caution
	Caution, hot surface
	Read the instructions before using the machine

2 Program description

2.1 General









The machine is equipped with a number of programs adapted to the range of use to which the machine is intended — different markets use different programs. The following program description is a short description of some examples of programs that can be used.

For a complete and detailed information about the all the available wash programs, please refer to ELS web-site.

It is recommended to follow the care labelling of the garment as far as possible.

2.2 Program description





The following table shows some examples of available programs and a short description of those:

Program	Description
NORMAL COLOUR 	Cotton and terry. Different temperatures can be selected. 30°C - 60°C. Detergent without bleach should be used. For an optimal result, full load is recommended.
NORMAL WHITE 	Cotton and terry. Different temperatures can be selected. 40°C - 95°C. Detergent with bleach should be used. For an optimal result, full load is recommended.
MILD 	Synthetic (example of synthetic fabrics: polyester, polyamide, polyacrylic and elasthan), viscose, polycotton and delicate fabrics. Different temperatures can be selected. 40°C - 60°C. For an optimal result, half load is recommended.
DELICATE 	Synthetic (example of synthetic fabrics: polyester, polyamide, polyacrylic and elasthan), viscose, polycotton and delicate fabrics. 30°C. For an optimal result, half load is recommended.
HANDWASH 	Very delicate fabrics. For an optimal result, only a few items is recommended.
WOOL 	Wool fabrics. 40°C. For an optimal result, only a few items is recommended.
RINSE 	Used for rinse and extraction.
ALLERGY 	A program which removes dust mites and the like. 60°C.
DRUM RINSE 	Used for rinse the drum and all compartments. Used with empty drum.

The following table shows some examples of different groups of programs that are used for special markets such as hospitals, restaurants, farms etc. and a short description of those:

Group of program	Description
General	Programs for normal household textiles and textiles in hotels and restaurants.
Mop	Programs for mops. Programs for workwear. Special mop program for microfibres.
Hygiene	Hygiene programs to meet the demands and recommendations of standards in different countries.
Farm	Programs for udder towels. Programs for workwear.
Camping	Short programs designed for slightly and normally soiled textiles.
Quick service restaurants	Programs for mops. Programs for workwear. Programs for fatty clothes

The following table shows some examples of available programs used on coin operated machines and a short description of those:











Program	Description
COLD 	Cotton and terry. 40°C. For an optimal result, full load is recommended.
WARM 	Cotton and terry. 60°C. For an optimal result, full load is recommended.
HOT 	Cotton and terry. 95°C. For an optimal result, full load is recommended.
MILD 	Synthetic (example of synthetic fabrics: polyester, polyamide, polyacrylic and elastan), viscose, polycotton and delicate fabrics. 40°C. For an optimal result, only a few items is recommended.
DELICATE 	Delicate fabrics. 30°C. For an optimal result, only a few items is recommended.

Program description

2.3 Option buttons

The machine is equipped with a number of options adapted to the range of use to which the machine is intended — different markets use different options.

The following table shows some examples of available options and a short description of those:

Option button		Description
	ECO PROGRAM	Washes using less water and energy. Eco friendly wash for normally soiled textiles.
	HEAVY SOIL	Long wash for heavy soiled textiles.
	QUICK PROGRAM	Short wash for light soiled textiles. The program will be ready as quick as possible.
	PREWASH	One pre-wash is added.
	EXTRA RINSE	One rinse is added.
	RINSE STOP	The program will pause before the last rinse.
	PRERINSE	Pre rinse(s) added.
	NO SOFTENER	On machines with automatic detergent dosing system. Push the button to select function: One push = No softener is added. Two pushes = No softener or detergent is added. Three pushes = Both softener and detergent is added.
	EXTRACTION	Different extraction times can be selected.
	GENTLE EXTRACTION	No extraction between rinses and short end extraction. For synthetics/blended textiles.

3 Handling

3.1 Load





Load the goods into the machine according to recommendations and close the door.

Maximum load	
W575S	8 kg
W585S	9 kg
W5105S	11 kg
W5130S	14 kg
W5180S	20 kg
W5250S	28 kg
W5330S	35 kg

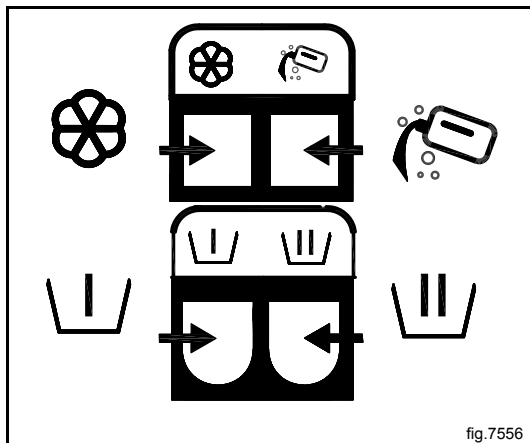
3.2 Detergent

Add the correct amount of detergent and softener according to recommendations.



	Softener, liquid.
	Main wash for liquid detergent. Alt. for mop machines, liquid mop chemicals in last rinse.
	Pre-wash, powder or liquid detergent, if option "pre-wash" has been selected.
	Main wash for powder detergent.

3.3 How to start the machine

This manual cover different types of machine models. Check the panel on your machine and follow the description for your type of machine.

3.3.1 AHL

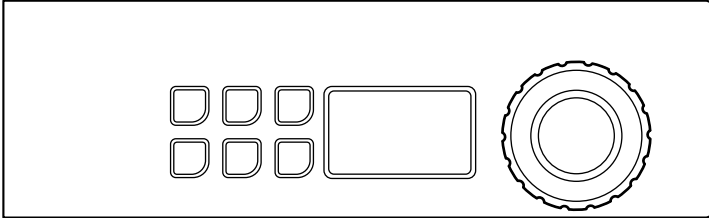









Select program by turning the control knob.

It is also possible to select one of the wash triangle options and/or other options.

Note!

Some programs do not allow options.

Example of programs	Wash triangle options		Example of other options	
<p>NORMAL COLOUR</p>  <p>Different temperatures can be selected. 30°C - 60°C.</p>		<p>ECO PROGRAM</p>		<p>PREWASH</p>
<p>NORMAL WHITE</p>  <p>Different temperatures can be selected. 40°C - 95°C.</p>		<p>HEAVY SOIL</p>		<p>EXTRA RINSE</p>
<p>MILD</p>  <p>Different temperatures can be selected. 40°C - 60°C.</p>		<p>QUICK PROGRAM</p>		<p>RINSE STOP</p>

Start the machine by pressing the control knob.

The machine will start by weighing the load with an extraction. The program will then adapt to the load to give an optimal result.

3.3.2 Mop

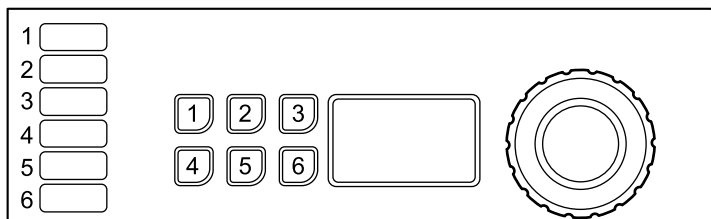







Select program by turning the control knob or select program with the quick selection buttons (if some of the buttons are programmed with this function).

It is also possible to select options (if some of the buttons are programmed with this function).

Note!

Some programs do not allow options.

Example of programs	Example of options programmed in the buttons	
MICROFIBRE 90 		PREWASH
MOP 85 		PRERINSE
RINSE 		EXTRACTION

Start the machine by pressing the control knob.

Buttons

The buttons on the panel can be programmed to be option buttons, quick selection buttons (used to select a program) or both.

At delivery the buttons are programmed to work as options buttons.

When installing the machine, a sticker is attached at each number corresponding to each button that explains what each button is used for.

The function of the buttons can be changed at any time. Information on how to program the buttons can be found in the Programming and configuration manual and should only be done by a skilled/authorized person.

3.3.3 Hygiene

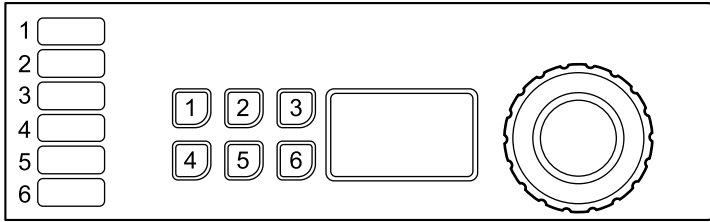







Select program by turning the control knob or select program with the quick selection buttons (if some of the buttons are programmed with this function).

It is also possible to select options (if some of the buttons are programmed with this function).

Note!

Some programs do not allow options.

Example of programs	Example of options programmed in the buttons	
NORMAL  Different temperatures can be selected. 40°C - 95°C.		PREWASH
MILD  Different temperatures can be selected. 40°C - 60°C.		PRERINSE
HANDWASH 		RINSE STOP

Start the machine by pressing the control knob.

Buttons

The buttons on the panel can be programmed to be option buttons, quick selection buttons (used to select a program) or both.

At delivery the buttons are programmed to work as options buttons.

When installing the machine, a sticker is attached at each number corresponding to each button that explains what each button is used for.

The function of the buttons can be changed at any time. Information on how to program the buttons can be found in the Programming and configuration manual and should only be done by a skilled/authorized person.

3.3.4 Restaurant

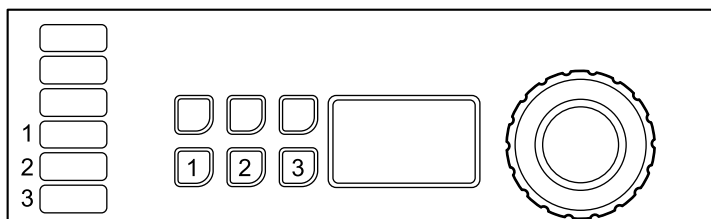









Select program by turning the control knob or select program with the quick selection buttons (if some or all of the buttons 1–3 are programmed with this function).

It is also possible to select one of the wash triangle options and/or other options (if some or all of the buttons 1–3 are programmed with this function).

Note!

Some programs do not allow options.

Example of programs	Wash triangle options		Example of options programmed in the buttons	
<p>NORMAL COLOUR</p>  <p>Different temperatures can be selected. 30°C - 60°C.</p>		<p>ECO PROGRAM</p>		<p>PREWASH</p>
<p>NORMAL WHITE</p>  <p>Different temperatures can be selected. 40°C - 95°C.</p>		<p>HEAVY SOIL</p>		<p>EXTRA RINSE</p>
<p>MILD</p>  <p>Different temperatures can be selected. 40°C - 60°C.</p>		<p>QUICK PROGRAM</p>		<p>RINSE STOP</p>

Start the machine by pressing the control knob.

Buttons

The buttons 1–3 on the panel can be programmed to be option buttons, quick selection buttons (used to select a program) or both.

At delivery the buttons are programmed to work as options buttons.



When installing the machine, a sticker is attached at each number corresponding to each button that explains what each button is used for.

The function of the buttons can be changed at any time. Information on how to program the buttons can be found in the Programming and configuration manual and should only be done by a skilled/authorized person.

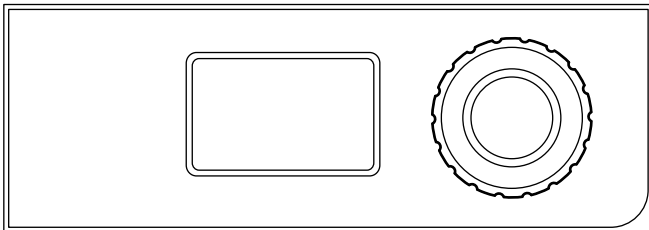
Restaurant with no buttons



Select program by turning the control knob.

Example of programs
<p>NORMAL COLOUR</p>  <p>Different temperatures can be selected. 40°C - 60°C.</p>
<p>NORMAL WHITE</p>  <p>Different temperatures can be selected. 40°C - 60°C.</p>



Start the machine by pressing the control knob.

The machine will start by weighing the load with an extraction. The program will then adapt to the load to give an optimal result.

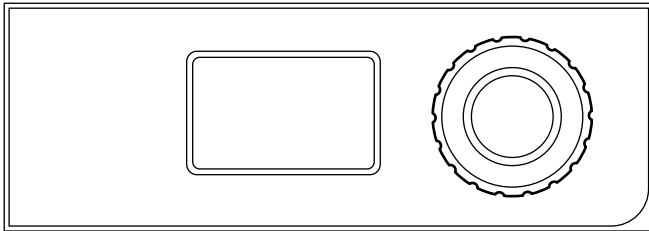
3.3.5 Camping



Select program by turning the control knob.

Example of programs
<p>NORMAL COLOUR</p>  <p>Different temperatures can be selected. 40°C - 60°C.</p>
<p>NORMAL WHITE</p>  <p>Different temperatures can be selected. 40°C - 60°C.</p>

Start the machine by pressing the control knob.

The machine will start by weighing the load with an extraction. The program will then adapt to the load to give an optimal result.

3.3.6 Coin operated machines

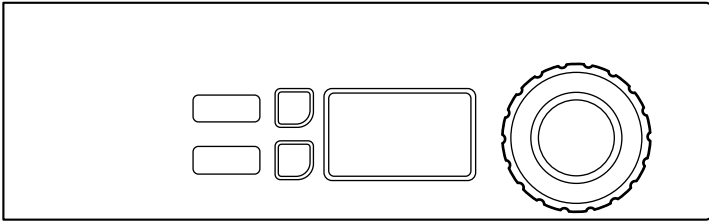





Select program by turning the control knob.

It is also possible to select options.

Note!

Some programs do not allow options.

Example of programs	Options	
COLD 		HEAVY SOIL
WARM  HOT 		EXTRA RINSE

Insert correct amount of coins to start the machine. (On some machines you also need to press the control knob to start the machine).

3.4 Additional functions

There is a menu with additional functions available for selection after start. When pressing the control knob / start button (on machines without control button) the menu will appear on the display. Select from the menu by turning the control knob / pressing the temperature button/-s and press the control knob / start button to activate.

Note!

Some of the functions may not be available or active on your machine.

Stop function

If the machine is programmed with this function, it is possible to stop the machine during program run by pressing the control knob.

When pressing the control knob again the program will continue.

Pause

It is possible to pause an ongoing program.

Select **PAUSE** and activate.

When pressing the control knob / start button again the program will continue.

The door can be opened after a short while if the water level is not too high. Close the door and press the control knob / start button to continue.

Changing a program after start

It is possible to change a program after start.

Select **CHANGE PROGRAM** and activate.

When pressing the control knob / start button the program menu will be displayed. Select a new program and start by pressing the control knob / start button.

Rapid advance

Select **RAPID ADVANCE** and activate.

When pressing the control knob / start button a list with all program steps will be displayed. Select desired program step from the list by turning the control knob / pressing the temperature button/-s and press the control knob / start button to activate.

End a program

It is possible to end a program after start.

Select **END PROGRAM** and activate.

When pressing the control knob / start button the program will be ended. When the water is drained the door will be unlocked.

Delayed start

If the machine has this function, it is possible to delay the start of a program.

After program selection, press the control knob / start button. A menu will appear on the display. Turn the control knob / press the temperature button/-s to activate the function. Set the day and time for the delayed start with the control knob / pressing the temperature button/-s.

Press the control knob / start button to confirm the settings.

Status

Select **STATUS MENU** and activate.

The status menu shows the status for water temperature, water level and drum speed for the machine.

Statistics

Select **STATISTICS** and activate.

The statistics menu shows total run hours and trip run hours for the machine.

Auto restarts

Select **AUTO RESTARTS** and activate.

Set the number of automatic restarts that the machine will perform of the selected program.

Press the control knob / start button to confirm the settings.

3.5 When program has ended

Leave the door open when ready. This is to prevent that moisture stays in the machine and develop bacteria and mould.

4 Timer

The timer is used to start a part of the program (for example the last rinse of the udder cloth program) after pause on a pre-set time. The time can be set for all days or for selected days.

To program the timer you need to activate the machines service mode.

The service mode is activated by a long press on the control knob.

SERVICE MENU
FUNCTION TEST
CONFIGURATION
PRICE PROGRAMMING
STATISTICS
PROGRAM PARAMETERS
SYSTEM

The following menus are activated by a short press on the control knob.

Activate the **PROGRAM PARAMETERS** menu.

SERVICE MENU
FUNCTION TEST
CONFIGURATION
PRICE PROGRAMMING
STATISTICS
PROGRAM PARAMETERS
SYSTEM

Activate the **SET START AFTER PAUSE** menu.

Activate the **ADD NEW OCCASION** menu.

The display will now show the following submenus:

- **BACK**
- **TIME**
- **ENABLED**
- **ALL DAYS**
- **MONDAY**
- **TUESDAY**
- **WEDNESDAY**
- **THURSDAY**
- **FRIDAY**
- **SATURDAY**
- **SUNDAY**
- **REMOVE OCCASION**

Activate the **TIME** menu to program the time. Set the time by turning the control knob and save when ready.

Select from the list and activate the day/days one by one by pressing the control knob. A filled square indicates that the day is activated.

Press **BACK** to exit and save the changes by selecting **YES**.

Example:

The program is started the day before and will pause before the last rinse.

If the time is set to 04.00 and **ALL DAYS** is activated, this means that the last rinse on the program will be started at 04.00 all days of the week.

When saved, the programmed time — occasion, will be listed in the **SET START AFTER PAUSE** menu as a new row.

It is possible to program several times — occasions on the same day.

Up to 10 occasions can be saved in the list.

Press **ENABLED** to activate or deactivate the selected occasion.

Press **REMOVE OCCASION** to delete the selected occasion.

5 Error codes

A fault in the program or in the machine is indicated by an error code on the display.

Some of these error codes can be solved easily without contacting service personnel.

Error code	Text	Cause/Action
11:1	NO WATER	Water level acknowledgement not reached in time. Check that the water taps are open.
11:2	DOOR OPEN	Door position acknowledgement not received during program. Open and close the door.
11:3	DOOR LOCK FAIL	Door position acknowledgement not received in time. Open and close the door.
11:10	DRUM NOT DRAINED	Water level above established level after drain. Check that the drain is not blocked. Try to restart the machine.

For other error codes or repeated error codes, disconnect the power for 30 seconds. If the error code keeps coming back, contact authorized service personnel.

6 Maintenance

6.1 General

It is the responsibility of the owner of the machine/the laundry manager to make sure that the following maintenance is performed.

Note!

Lack of maintenance may deteriorate the performance of the machine and may cause damage to components.

Note!

This is recommended time intervals. Depending on the use of the machine other intervals may be necessary.

6.2 Time for maintenance

When the display is showing the message **TIME FOR MAINTENANCE** — contact the owner of the machine/the laundry manager to perform maintenance (if available, a telephone number and/or a tag will also be displayed).

The machine can be used meanwhile. However, the message will keep coming back until the service is performed.

The message will disappear after about 30 seconds or if the control knob or any button is pressed.

6.3 Every day

Check that the door is locked during a program. Make sure the door cannot be opened until after the program is complete.

If the door can be opened before program end, the machine must be placed out of order until repairs are made.

Check that the door does not leak.

Clean the door, door glass and door gasket.

Clean the external parts.

6.4 Detergent container

Clean the detergent container at regular basis to avoid that it is being clogged by detergent residue.

6.4.1 Deliming

When deliming is needed:

Use the special machine cleaning program. If it is not available, contact authorized service personnel to get access to the program.

It is also possible to use a program with high temperature, 95°C, for deliming. Add a deliming agent, for example citric acid.

6.5 Drain

At regular basis, check the drain connection, joints in the drain pipe etc and remove any lint and dust. Clean with for example a small brush. When remounting, make sure the connections are tight.

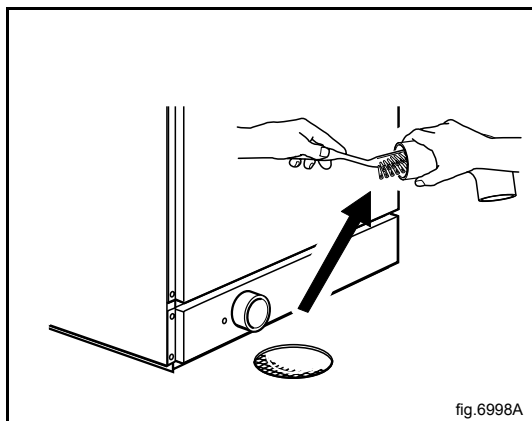

6.6 Water inlet

At regular basis, check the filter at the water inlet. Clean if necessary.

Demount the hose to the water inlet and pull out the filter (A).

When remounting, make sure the filter is in position and that the connections are tight.

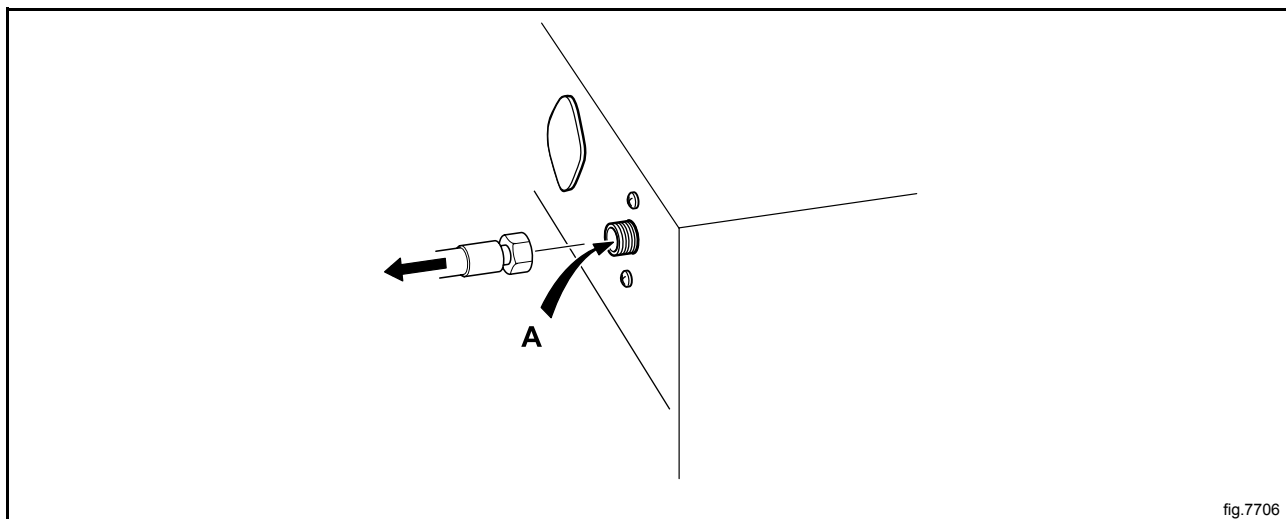

6.7 Cleaning the mop elements

(Only valid for mop machines).

At regular basis, check the mop elements and clean if necessary.

In the inner drum, there is one or two core covers to the heating elements depending on the size of the machine. The front cover is located directly above the drain and the other is in front of the element retainer. Two small screwdrivers are required to remove the core cover.

Use a screwdriver to press down on the retaining plate in the round hole on the core cover.

Place the other screwdriver in the oval hole on the core cover and through the round hole in the retaining plate.

Push the retaining plate towards the screwdriver which is pressing down on the retaining plate.

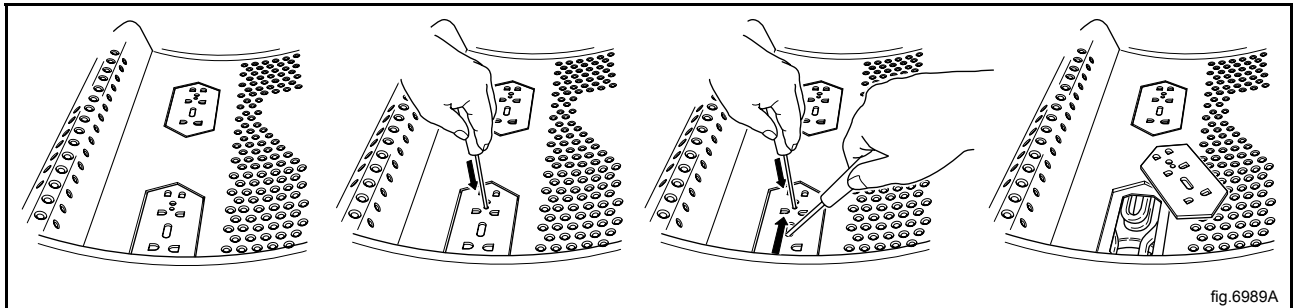

Remove the core element/elements and clean the elements. If the elements are very dirty, it may be wise to remove the elements from the drum when cleaning them

The core covers are refitted in reverse order, with the difference that it is not necessary to press on the retaining plate; you only need to push the retaining plate back into place. When you hear a clicking sound, the retaining plate is in position.

6.8 Maintenance to be carried out by qualified service personnel

Contact qualified service personnel to perform the following maintenance:

Once a year:

- Inspect the interior of the machine during an actual wash cycle to ensure that no leaks are noticed.



Skrotning av maskin

När maskinen inte längre skall användas måste den lämnas till en återvinningsstation för destruktion. Många detaljer i maskinen går att återanvända, men den innehåller även annat material som måste tas om hand på ett korrekt sätt. Lämna därför aldrig maskinen eller delar av maskinen i hushållsavfallet, eftersom det kan leda till hälsorisker eller skador på miljön.

Scrapping of machine

When the machine is no longer to be used, it must be submitted to a recycling facility for destruction. The majority of the components in the machine can be reused, but it also contains other material that must be taken care of in the correct way. Therefore, never mix the machine or its parts with domestic waste as this may lead to health hazards or damage to the environment.

Entsorgung des Geräts

Wenn das Gerät nicht länger im Gebrauch ist, muss dieses einer Recyclingstation zur Entsorgung zugeführt werden. Viele Komponenten des Geräts sind recyclingfähig, enthalten aber auch Materialien, die vorschriftsmäßig entsorgt werden müssen. Entsorgen Sie daher das Gerät oder Geräteteile niemals im Hausmüll, da dies Gefahren für die Gesundheit oder Umweltschäden nach sich ziehen kann.

Mise au rebut de machine

Lorsque la machine n'est plus utilisée, elle doit être déposée à une installation de recyclage pour y être détruite. La majorité des composants de la machine peuvent être réutilisés mais celle-ci contient également d'autres matériaux qui doivent être traités correctement. C'est pourquoi vous ne devez jamais mélanger la machine ou ses pièces avec les ordures ménagères, risque de pollution pour l'environnement ou la santé.

Desguace de la máquina

Cuando la máquina no tenga que utilizarse más, ha de entregarse a una instalación de destrucción para su reciclado. La mayor parte de sus componentes pueden volver a utilizarse, pero consta también de otros materiales que han de ser tratados de la manera correcta. Por esa razón nunca mezclar la máquina ni sus partes con la basura doméstica pues esto podría constituir un peligro para la salud o dañar el medio ambiente.

Bortskaffelse af maskinen

Når maskinen ikke længere er i brug, skal den afleveres til destruktion på en genbrugsstation. Mange dele i maskinen kan genanvendes, men den indeholder også andre materialer, der skal håndteres korrekt. Smid derfor ikke maskinen eller dele af den ud sammen med husholdningens almindelige affald, da det kan være forbundet med sundhedsrisiko eller give miljøskader.

Koneen hävittäminen

Kun koneita ei enää käytetä, se pitää luovuttaa kierrätyskeskukseen tuhottavaksi. Suurinta osaa koneen osista voidaan käyttää uudelleen, mutta se sisältää myös materiaaleja, jotka pitää käsitellä asianmukaisesti. Älä sen vuoksi koskaan laita koneita tai sen osia kotitalousjätteen sekaan, sillä se saattaa aiheuttaa terveysriskejä tai vahinkoa ympäristölle.

Skrotning av maskin

Når maskinen ikke lenger skal brukes, må den leveres til en gjenvinningsstasjon for destruksjon. Det går an å gjenbruke mange deler av maskinen, men den inneholder også annet materiale som man må ta hånd om på riktig måte. Legg derfor aldri maskinen eller deler av maskinen i husholdningsavfallet, siden det kan føre til helse- eller miljøskader.

Afdanken van de machine

Als de machine niet langer gebruikt gaat worden, moet deze ter vernietiging worden aangeboden bij een recyclinginrichting. De meeste componenten van de machine kunnen worden hergebruikt, maar hij bevat ook ander materiaal dat op een juiste wijze moet worden behandeld. Daarom de machine of zijn onderdelen nooit bij het huisvuil zetten, want dat kan leiden tot gezondheidsrisico's of schade aan het milieu.

Rottamazione della macchina

Quando la macchina non può più essere utilizzata, deve essere affidata a un centro di riciclaggio che ne effettui la rottamazione. La maggior parte dei componenti della macchina sono riciclabili, ma ce ne sono anche alcuni che devono essere smaltiti in modo appropriato. Perciò, non mischiare mai la macchina o parti di essa con i normali rifiuti domestici, poiché ciò potrebbe comportare rischi per la salute o per l'ambiente.

Złomowanie maszyny

Wycofaną z użytkowania maszynę należy przekazać do zakładu utylizacji w celu złomowania. Większość podzespołów maszyny nadaje się do powtórnego wykorzystania, lecz zawiera ona także inne materiały, z którymi należy postępować w odpowiedni sposób. Z tego powodu niedozwolone jest łączenie maszyny lub jej części z odpadami domowymi, gdyż może to prowadzić do zagrożenia zdrowia lub szkody dla środowiska.

Vyřazení přístroje

Přístroj, který již nebude používán, by měl být odevzdán k likvidaci do ekodvora. Většina součástí přístroje může být opětovně použita, některé ale vyžadují likvidaci přesně daným způsobem. A proto nikdy nemíchejte dohromady přístroje nebo jejich části s domácím odpadem, mohlo by to vést ke zdravotním rizikům nebo k poškození životního prostředí.

Οριστική απόσυρση μηχανήματος

Όταν το μηχάνημα δεν προορίζεται για περαιτέρω χρήση, θα πρέπει να οδηγείται σε εγκατάσταση ανακύκλωσης για καταστροφή. Το μεγαλύτερο ποσοστό των εξαρτημάτων του μηχανήματος μπορεί να χρησιμοποιηθεί ξανά, αλλά το μηχάνημα περιλαμβάνει και άλλα υλικά η διαλογή των οποίων θα πρέπει να πραγματοποιείται με τον κατάλληλο τρόπο. Κατά συνέπεια, μην αναμειγνύετε ποτέ το μηχάνημα ή τα εξαρτήματά του με οικιακά απορρίμματα καθώς αυτό μπορεί να αποβεί επικίνδυνο για την υγεία ή επιβλαβές για το περιβάλλον.



Thinking of you
Electrolux

Electrolux Laundry Systems Sweden AB
341 80 Ljungby, Sweden
www.electrolux.com/laundrysystems

Share more of our thinking at www.electrolux.com